



Manual Liquid Handling

Catalog





Welcome to Gilson

Your liquid samples, handled!

In the world of science, sample quality is key. That's why you've trusted Gilson for such a long time. We help transforming liquid volume data into actionable research insights. Our portfolio of precision solutions helps the world's largest and most successful laboratories, in more than 90 countries, to get the right result with the lowest risk.

In the early 1970's Gilson enabled scientists to push science a step further with the creation of the world famous mechanical pipette: PIPETMAN. Today, with the introduction of PIPETMAX, the fusion of the PIPETMAN reliability and the unmatched Gilson know-how in automation of manual processes, Gilson allows every scientist to take their work to the next level, doing more and refocusing on science. Working as a trusted partner, Gilson provides not only outstanding products and services, but also proactive ideas and innovative solutions to ensure our clients will continue to succeed tomorrow.

We, at Gilson, are dedicated to making your life easier, providing a wide and reliable range of manual to automated liquid handling solutions, including pipettes, pipette tips, pipette accessories, benchtop sample preparation equipment and tailor-made services. Browsing through the catalog pages, you'll find the best solutions and the most cost effective ways to manage your liquid samples, enabling you to successfully complete your research, with complete confidence in your sample preparation steps.

Enjoy your research!



Total commitment to our customers' satisfaction

In accordance with the ISO 9001, our company's organization is based on processes addressing customers' needs.



High quality of conception and calibration of our products

Our pipettes are designed, manufactured and calibrated in compliance with the specifications and methods of the ISO 8655 standard.



Guarantee of our pipettes' safety for In Vitro Diagnostics

All our pipettes comply with the IVD Directive (98/79/EC) for In Vitro Diagnostics Medical Devices.

Their conception take into account the specifics of use in clinical laboratories, in order to control risks which are associated with such use.



Guarantee of our electronic pipettes to conform with the Low Voltage (LV) norm

LV identifies safety considerations of an electricity supply system based on the voltage used. LV is characterised by carrying a substantial risk of electric shock.



Guarantee of our electronic and digital pipettes to conform with the Electromagnetic Compatibility norm (EMC)

The goal of EMC is the correct operation, in the same electromagnetic environment, of different equipment which use electromagnetic phenomena, and the avoidance of any interference effects.



High technical and metrological performances of our calibration laboratory

Our independent pipette calibration laboratory is accredited by a national accreditation organization:

- For its ability to calibrate pipettes in accordance with the ISO 8655.
- For its capacity to reproduce reliable results.
- For the reliability of its quality system.

NEW

MECHANICAL PIPETTES

PIPETMAN® L Single, Multi & Fixed	4-9
PIPETMAN® G	10-11
PIPETMAN Neo® Single & Multi	12-13
PIPETMAN Classic™	14
PIPETMAN® Fixed	15

NEW

ELECTRONIC-MOTORIZED PIPETTES

PIPETMAN® M Single & Multi	16-19
PIPETMAN Concept® (Single and Multichannel).....	20-21

NEW

PIPETTE AUTOMATION

PIPETMAX	22-23
----------------	-------

PIPETTE KITS

PIPETMAN G, PIPETMAN Neo, PIPETMAN Classic	24
--	----

PIPETTE ACCESSORIES

CARROUSEL™, SINGLE™ Pipette Holder, TRIO™ Pipette Stand, Universal Multichannel Stand, Gilson Reagent Reservoirs, Corrosion Protection Kit, Name Tags, COLORIS™ Identification Clips, THE JIMMY™ Microtube Opener	25
---	----

PIPETTE TIPS

PIPETMAN DIAMOND™ Tips:

Standard tips, Filter tips, Sterilized tips	26-29
---	-------

Packaging:

TIPACK™, TOWER PACK™, STERILPACK™, ECOPACK™, EASYPACK™, Empty Racks	26-29
--	-------

PERSONAL LABORATORY ASSISTANT

TRACKMAN	30-31
----------------	-------

POSITIVE DISPLACEMENT PIPETTE

MICROMAN® and Capillary Pistons	32-33
---------------------------------------	-------

MANUAL AND ELECTRONIC REPEATER PIPETTES

DISTRIMAN® and DistriTips®	34
REPETMAN® and Repet-Tips	35

MOTORIZED PIPETTE FILLER

MACROMAN™	36
-----------------	----

BENCHTOP SOLUTIONS

Gilson Safe Aspiration Station	37
MINIPULS Evolution®	38-39
MINIPULS® 3 Peristaltic Pump	40
MINIPULS Tubing	41
MINIPULS Applications	42
GmCLab mini centrifuge	43
ISO 17025 and Gilson Pipettes	44-45

SERVICES

Gilson Service network of trained distributors, Gilson Preventive Maintenance	46
On-Site Service, The "Center of Excellence" Label	47
Gilson training, Do-it-yourself Performance Check	47

PIPETTES REPLACEMENT PARTS	48-51
----------------------------------	-------

AUTOMATED INSTRUMENTATION	52
---------------------------------	----

APPENDIX - CHEMICAL COMPATIBILITY TABLE	53
---	----

WEBSITES AND LITERATURE	54
-------------------------------	----



pipetman® L

Comfortable and Secure by Nature!



PIPETMAN L is the new fully-adjustable, air displacement pipette based on ergonomics, comfort and traceability research. The newly designed body offers a high comfort without sacrificing robustness, accuracy and precision.

Eight single-channel models cover a range of volumes from 0.2 µL to 10 mL.

ONE OF THE LOWEST* PIPETTING FORCES ON THE MARKET

- A new shape and new mechanism for the tip ejection system dramatically reduce the tip ejection forces.
- A new piston assembly has been developed to drastically improve the pipetting and purge forces.

**Tested on Gilson and other brands of 200 µL pipette or equivalent.*

OPTIMUM TRACEABILITY

- A 2D code that includes the product reference, date of manufacture, the serial number and the nominal volume.
- A universal scanner or a smartphone* is sufficient to download pipette information.

**Data matrix barcode on PIPETMAN L is readable with a smartphone by simply downloading a special application used for universal barcodes.*



CLASSIC METAL OR PLASTIC EJECTORS?

- Stainless steel or plastic ejectors are available with always the same legendary PIPETMAN robustness.
- For a convenient access to the serviceable parts, the pipette is equipped with the Gilson clip ejector (see photo page 13 for details).

Gilson clip ejector





IMPROVED COMFORT

- 1 To protect from repetitive strain injuries (RSI), a new piston assembly has been designed to drastically reduce forces.
- 2 Its new shape ensures a perfect fit while the new hook reduces tensions while holding it.
- 3 To guarantee the volume delivered, a comfortable and reliable locking system has been developed.
- 4 An adjustable tip ejector button has been implemented to adapt to both right and left handed users.



Watch the video!



Trusted results

PIPETMAN L's specifications are more stringent than those required to be ISO 8655 compliant.

PIPETMAN L Models	PIPETMAN DIAMOND Tips*		Ordering reference		Volume (μL)	Maximum Permissible Errors			
						Gilson		ISO 8655	
						Systematic error (μL)	Random error (μL)	Systematic error (μL)	Random error (μL)
P2L	D10 DL10	DF10 DFL10	FA10001M	FA10001P	0.2	± 0.024	≤ 0.012	± 0.08	≤ 0.04
					0.5	± 0.025	≤ 0.012	± 0.08	≤ 0.04
					1	± 0.027	≤ 0.013	± 0.08	≤ 0.04
					2	± 0.030	≤ 0.014	± 0.08	≤ 0.04
P10L**	D10 DL10	DF10 DFL10	FA10002M	FA10002P	1	± 0.025	≤ 0.012	± 0.12	≤ 0.08
					5	± 0.075	≤ 0.030	± 0.12	≤ 0.08
					10	± 0.100	≤ 0.040	± 0.12	≤ 0.08
P20L	D200	DF30	FA10003M	FA10003P	2	± 0.10	≤ 0.030	± 0.2	≤ 0.1
					10	± 0.10	≤ 0.050	± 0.2	≤ 0.1
					20	± 0.20	≤ 0.060	± 0.2	≤ 0.1
P100L	D200	DF100	FA10004M	FA10004P	10	± 0.35	≤ 0.10	± 0.8	≤ 0.3
					50	± 0.40	≤ 0.12	± 0.8	≤ 0.3
					100	± 0.80	≤ 0.15	± 0.8	≤ 0.3
P200L	D200 D300	DF200 DF300	FA10005M	FA10005P	20	± 0.50	≤ 0.20	± 1.6	≤ 0.6
					100	± 0.80	≤ 0.25	± 1.6	≤ 0.6
					200	± 1.60	≤ 0.30	± 1.6	≤ 0.6
P1000L	D1000 D1200	DF1000 DF1200	FA10006M	FA10006P	100	± 3.0	≤ 0.6	± 8.0	≤ 3.0
					500	± 4.0	≤ 1.0	± 8.0	≤ 3.0
					1000	± 8.0	≤ 1.5	± 8.0	≤ 3.0
P5000L	D5000		FA10007		500	± 12	≤ 3	± 40	≤ 15.0
					2500	± 15	≤ 5	± 40	≤ 15.0
					5000	± 30	≤ 8	± 40	≤ 15.0
P10mL L	D10mL		FA10008		1000	± 30	≤ 6	± 60	≤ 30.0
					5000	± 40	≤ 10	± 60	≤ 30.0
					10000	± 60	≤ 16	± 60	≤ 30.0

* Recommended tip for establishing maximum permissible errors (ISO 8655 requirement). A large range of suitable PIPETMAN DIAMOND Tips is available. (See pages 26-29).

** P10L model can be used up to 0.5 μL.

- PIPETMAN L pipettes are available with a calibration certificate issued by an ISO 17025 accredited laboratory, upon request. (See pages 44-45).

Model	Ordering reference
Vial of lubricant	5440011070



Comfortable and Secure by Nature!

Enjoy the ease of use of PIPETMAN L combined with the well-known advantages of the PIPETMAN Neo Multichannel lower part.

Eight multichannel models cover a range of volumes from 0.5 µL to 300 µL.

4 REASONS TO CHOOSE PIPETMAN L MULTICHANNEL

- 1 Volume secured.
- 2 2D code traceability.
- 3 Extremely comfortable.
- 4 Specially designed to transfer liquid to 96 and 384 well-micro plates.

INNOVATIVE PATENTED PISTON DRIVE MECHANISM



- The specific rack rail mechanism guarantees identical performance on each channel.
- Thanks to an exclusive patented piston drive mechanism, the pressure is applied consistently and simultaneously on each piston, resolving the common downfall of multichannel pipettes: disparities between channels of the volume distributed.

INGENIOUS TIP EJECTOR TECHNOLOGY

- For more comfort, the ejector spacer has been designed to apply equal ejection forces over each tip sequentially.
- This system drastically reduces tip ejection forces and risks of RSI.

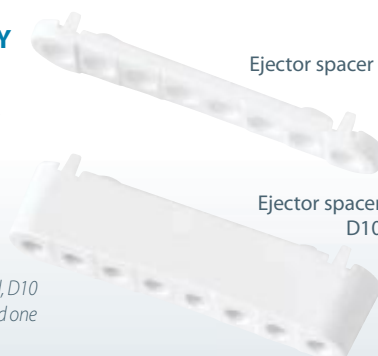

For PIPETMAN L Multichannel 10 µL: According to the tip used, D10 or DL10, you might have to exchange the ejector spacer; the broad one is dedicated to D10, and the small one is dedicated to DL10.

UNIQUE TIP-HOLDER DESIGN





- Successive rings have been positioned depending on the pipette volume range to guaranty the snug fit of tips throughout the protocols.





Trusted results

Best results guaranteed with a performance exceeding ISO recommendations.

PIPETMAN M MULTI Models	PIPETMAN DIAMOND Tips*	Ordering reference	Volume (µL)	Maximum Permissible Errors			
				Gilson		ISO 8655	
				Systematic error (µL)	Random error (µL)	Systematic error (µL)	Random error (µL)
	L8x10	D10	0.5	± 0.08	≤ 0.04	± 0.24	≤ 0.16
	L12x10	DL10	1	± 0.08	≤ 0.05	± 0.24	≤ 0.16
		DF10	5	± 0.20	≤ 0.10	± 0.24	≤ 0.16
		DFL0	10	± 0.20	≤ 0.10	± 0.24	≤ 0.16
	L8x20	DL10	2	± 0.10	≤ 0.08	± 0.4	≤ 0.20
	L12x20	DFL10	10	± 0.20	≤ 0.10	± 0.4	≤ 0.20
		DF30	20	± 0.40	≤ 0.15	± 0.4	≤ 0.20
		D200					
	L8x200	D200	20	± 0.50	≤ 0.25	± 3.2	≤ 1.2
	L12x200	D300	100	± 1.00	≤ 0.40	± 3.2	≤ 1.2
		DF200	200	± 2.00	≤ 0.50	± 3.2	≤ 1.2
		DF300					
	L8x300	D200	20	± 1.00	≤ 0.35	± 8.0	≤ 3.0
	L12x300	D300	30	± 1.00	≤ 0.35		
		DF200	150	± 1.50	≤ 0.60		
		DF300	300	± 3.00	≤ 1.00		

* Recommended tip for establishing maximum permissible errors (ISO 8655 requirement). A large range of suitable PIPETMAN DIAMOND Tips is available. (See pages 26-29).

 • PIPETMAN L Multi pipettes are available with a calibration certificate issued by an ISO 17025 accredited laboratory, upon request. (See pages 44-45).

Watch the video!



Complete your equipment with:



Accessories	Ordering reference
TRIO, stand for 3 pipettes	F161405
Universal Multichannel stand	F161417
CARROUSEL, stand for 7 pipettes	F161401
Name tags (x6)	FA07082

Product	Ordering reference
TRACKMAN	F70301





Enjoy the advantages of PIPETMAN L family, combined with high quality of results in the easiest and lightest way.

Fifteen models cover a range of volumes from 1 µL to 5000 µL.

4 REASONS TO CHOICE PIPETMAN L FIXED

- 1 High quality of results.
- 2 Safety: no risk of error of delivered volume.
- 3 Extremely comfortable.
- 4 Easy to use.

Watch the video!



PUSH BUTTON

- The lower part is colored in blue to make difference between variable and fixed models easier.



GRADUATED COVER

- Can be readjusted by users in the laboratory, for dense or viscous fluids (once reset the new volume cannot be changed accidentally).

PLASTIC EJECTOR





- The pipette is available only with plastic ejector.
- For a convenient access to the serviceable parts, the pipette is equipped with the Gilson clip ejector (see photo page 13 for details).





Trusted results

PIPETMAN L Fixed's specifications are more stringent than those required to be ISO 8655 compliant.

PIPETMAN L Fixed Model	Ordering reference	PIPETMAN DIAMOND Tips*	Volume (µL)	Maximum Permissible Errors					
				Gilson		ISO 8655			
				Systematic error (µL)	Random error (µL)	Systematic error (µL)	Random error (µL)		
	F1L	FA10017	D10 DF10 DL10 DFL10	1	± 0.020	≤ 0.015	± 0.05	≤ 0.05	
	F2L	FA10018		2	± 0.050	≤ 0.020	± 0.08	≤ 0.04	
	F5L	FA10019		5	± 0.050	≤ 0.025	± 0.125	≤ 0.075	
	F10L	FA10020		10	± 0.060	≤ 0.030	± 0.12	≤ 0.08	
	F20L	FA10021	D200 DF30	20	± 0.100	≤ 0.050	± 0.2	≤ 0.1	
	F25L	FA10022		25	± 0.200	≤ 0.070	± 0.5	≤ 0.2	
	F50L	FA10023		D200 DF100	50	± 0.35	≤ 0.12	± 0.5	≤ 0.2
	F100L	FA10024			100	± 0.55	≤ 0.15	± 0.8	≤ 0.3
F200L	FA10025	D200 DF200	200	± 1.20	≤ 0.30	± 1.6	≤ 0.6		
	F250L	FA10026	D300 DF300	250	± 1.50	≤ 0.75	± 4.0	≤ 1.5	
	F300L	FA10027	D1000 DF1000	300	± 2.4	≤ 0.5	± 4.0	≤ 1.5	
	F400L	FA10028		400	± 2.4	≤ 0.8	± 4.0	≤ 1.5	
	F500L	FA10029		500	± 3.0	≤ 0.8	± 4.0	≤ 1.5	
	F1000L	FA10030		1000	± 5.0	≤ 1.3	± 8.0	≤ 3.0	
	F5000L	FA10031	D5000	5000	± 20.0	≤ 7.0	± 40	≤ 15.0	

* Recommended tip for establishing maximum permissible errors (ISO 8655 requirement).
A large range of suitable PIPETMAN DIAMOND Tips is available. (See pages 26-29).

 • PIPETMAN L Fixed pipettes are available with a calibration certificate issued by an ISO 17025 accredited laboratory, upon request. (See pages 44-45).

Model	Ordering reference
Vial of lubricant	5440011070

Complete your equipment with:

Accessories	Ordering reference
TRIO, stand for 3 pipettes	F161405
CARROUSEL, stand for 7 pipettes	F161401
Name Tags (x6)	FA07082





PIPETMAN G is a new mechanical, air-displacement pipette from Gilson. In addition to the same legendary robustness, accuracy and precision, PIPETMAN G offers you the lowest pipetting forces on the market for the highest comfort.

Eight single channel models cover a range of volumes from 0.2 µL to 10 mL.

A BLUE RING FOR EASY IDENTIFICATION

To distinguish the PIPETMAN G from the PIPETMAN Neo or Classic, a blue ring has been placed under the thumbwheel.



Blue ring
= PIPETMAN G

- P2 and P10 are equipped with extension for tip-ejector (Ref. F144879), allowing the use of PIPETMAN DIAMOND D10 (short) and DL10 (long) tips: a plus for protection and precision when using microtubes.

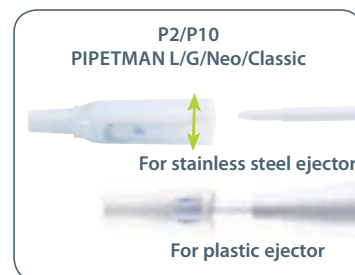

TAKE COMFORT TO THE NEXT LEVEL

- Thanks to the redesigned piston assembly (new seal, lighter springs) and the addition of high quality piston grease, you can enjoy one of the lowest* pipetting force available on the market.

**Tested on Gilson and other brands of 200 µL pipette or equivalent.*

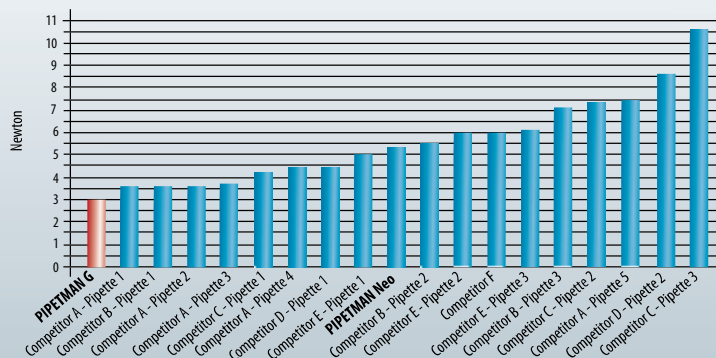



PIPETMAN G is also available in kit!

See page 24 for more information



CLASSIC METAL OR PLASTIC EJECTORS?

- Stainless steel or plastic ejectors are available with always the same legendary PIPETMAN robustness.
- For a convenient access to the serviceable parts, the pipette is equipped with the Gilson clip ejector (see photo page 13 for details).

Trusted results

PIPETMAN G's specifications are more stringent than those required to be ISO 8655 compliant.

PIPETMAN G Models	PIPETMAN DIAMOND Tips*		Ordering reference		Volume (μL)	Maximum Permissible Errors			
						Gilson		ISO 8655	
			With stainless steel ejector	With plastic ejector		Systematic error (μL)	Random error (μL)	Systematic error (μL)	Random error (μL)
P2G	D10	DF10	F144054M	F144054P	0.2	± 0.024	≤ 0.012	± 0.08	≤ 0.04
	DL10	DFL10			0.5	± 0.025	≤ 0.012	± 0.08	≤ 0.04
					2	± 0.030	≤ 0.014	± 0.08	≤ 0.04
P10G**	D10	DF10	F144055M	F144055P	1	± 0.025	≤ 0.012	± 0.12	≤ 0.08
	DL10	DFL10			5	± 0.075	≤ 0.030	± 0.12	≤ 0.08
					10	± 0.100	≤ 0.040	± 0.12	≤ 0.08
P20G	D200	DF30	F144056M	F144056P	2	± 0.10	≤ 0.030	± 0.2	≤ 0.1
					10	± 0.10	≤ 0.050	± 0.2	≤ 0.1
					20	± 0.20	≤ 0.060	± 0.2	≤ 0.1
P100G	D200	DF100	F144057M	F144057P	10	± 0.35	≤ 0.10	± 0.8	≤ 0.3
					50	± 0.40	≤ 0.12	± 0.8	≤ 0.3
					100	± 0.80	≤ 0.15	± 0.8	≤ 0.3
P200G	D200	DF200	F144058M	F144058P	20	± 0.50	≤ 0.20	± 1.6	≤ 0.6
	D300	DF300			100	± 0.80	≤ 0.25	± 1.6	≤ 0.6
					200	± 1.60	≤ 0.30	± 1.6	≤ 0.6
P1000G	D1000	DF1000	F144059M	F144059	100	± 3.0	≤ 0.6	± 8.0	≤ 3.0
	D1200	DF1200			500	± 4.0	≤ 1.0	± 8.0	≤ 3.0
					1000	± 8.0	≤ 1.5	± 8.0	≤ 3.0
P5000G	D5000		F144066		500	± 12	≤ 3	± 40	≤ 15.0
					2500	± 15	≤ 5	± 40	≤ 15.0
					5000	± 30	≤ 8	± 40	≤ 15.0
P10mL G	D10mL		F144067		1000	± 30	≤ 6	± 60	≤ 30.0
					5000	± 40	≤ 10	± 60	≤ 30.0
					10000	± 60	≤ 16	± 60	≤ 30.0

* Recommended tip for establishing maximum permissible errors (ISO 8655 requirement). A large range of suitable PIPETMAN DIAMOND Tips is available. (See pages 26-29).

** P10G model can be used up to 0.5 μL.

- PIPETMAN G pipettes are available with a calibration certificate issued by an ISO 17025 accredited laboratory, upon request. (See pages 44-45).

Model	Ordering reference
Vial of lubricant	5440011070



pipetman[®] NEO

The Pipetting Standard With Improved Comfort!



PIPETMAN Neo exhibits a distinct enhancement in comfort and a wide useful volume-range with the same legendary robustness, accuracy and precision as PIPETMAN Classic.

With uncontested reliability and durability, PIPETMAN Neo Multi is the economical, efficient solution to years of pipetting comfort.

PIPETMAN Neo is available in :

- Six single-channel models cover a range of volumes from 0.2 μ L to 1000 μ L,
- 4 multichannel models cover a range of volumes from 2 to 200 μ L.

UP TO 50% REDUCTION OF PIPETTING FORCES

- Newly engineered springs are wound to provide a significant reduction of pipetting and purge forces.
- Up to 50% reduction of pipetting and purge forces on certain models.

COLOR-CODED PUSH-BUTTONS

- Color-coded push-buttons facilitate identification of the different models and corresponding quality PIPETMAN DIAMOND Tips.
- Helps differentiate PIPETMAN Neo pipettes from PIPETMAN Classic models.



PIPETMAN Neo is also available in kit!

See page 24 for more information

PREMIUM ROBUSTNESS

- Made of highly resistance materials, PIPETMAN Neo offers excellence in robustness and durability. Built to last, your pipette will have a long, productive life with routine maintenance and service.

WIDE USEFUL VOLUME RANGE

- Specifications provided at 10%, 50% and 100% of the nominal volume, as recommended by the ISO8655 standard.

CLIP EJECTOR FOR AN EASIER DISMANTLING AND GREATER TIP FITTING

- The clip ejector results in easier daily operation and even more robust system over time.
- Thanks to this improvement, the ejector clips securely in place without risk of it slipping over time.



Trusted results

PIPETMAN Neo's specifications are more stringent than those required to be ISO 8655 compliant.

PIPETMAN Neo Models	PIPETMAN DIAMOND Tips*		Ordering reference	Volume (µL)	Maximum Permissible Errors			
					Gilson		ISO 8655	
					Systematic error (µL)	Random error (µL)	Systematic error (µL)	Random error (µL)
P2N	D10 DL10	DF10 DFL10	F144561	0.2	± 0.024	≤ 0.012	± 0.08	≤ 0.04
				0.5	± 0.025	≤ 0.012	± 0.08	≤ 0.04
				1	± 0.025	≤ 0.012	± 0.08	≤ 0.04
				2	± 0.030	≤ 0.014	± 0.08	≤ 0.04
P10N**	D10 DL10	DF10 DFL10	F144562	1	± 0.025	≤ 0.012	± 0.12	≤ 0.08
				5	± 0.075	≤ 0.030	± 0.12	≤ 0.08
				10	± 0.100	≤ 0.040	± 0.12	≤ 0.08
P20N	D200	DF30	F144563	2	± 0.10	≤ 0.030	± 0.2	≤ 0.1
				10	± 0.10	≤ 0.050	± 0.2	≤ 0.1
				20	± 0.20	≤ 0.060	± 0.2	≤ 0.1
P100N	D200	DF100	F144564	10	± 0.35	≤ 0.10	± 0.8	≤ 0.3
				50	± 0.40	≤ 0.12	± 0.8	≤ 0.3
				100	± 0.80	≤ 0.15	± 0.8	≤ 0.3
P200N	D200 D300	DF200 DF300	F144565	20	± 0.50	≤ 0.20	± 1.6	≤ 0.6
				100	± 0.80	≤ 0.25	± 1.6	≤ 0.6
				200	± 1.60	≤ 0.30	± 1.6	≤ 0.6
P1000N	D1000 D1200	DF1000 DF12000	F144566	100	± 3.0	≤ 0.6	± 8.0	≤ 3.0
				500	± 4.0	≤ 1.0	± 8.0	≤ 3.0
				1000	± 8.0	≤ 1.5	± 8.0	≤ 3.0
8x20 12x20	DL10 D200	DFL10 DF30	F14401 F14402	2	± 0.10	≤ 0.08	± 0.4	≤ 0.2
				10	± 0.20	≤ 0.10	± 0.4	≤ 0.2
				20	± 0.40	≤ 0.20	± 0.4	≤ 0.2
8x200 12x200	D200 D300	DF100 DF200 DF300	F14403 F14404	20	± 0.50	≤ 0.25	± 3.2	≤ 1.2
				100	± 1.00	≤ 0.40	± 3.2	≤ 1.2
				200	± 2.00	≤ 0.60	± 3.2	≤ 1.2

- PIPETMAN Neo pipettes are available with a calibration certificate issued by an ISO 17025 accredited laboratory, on request. (See pages 44-45).

* Recommended tip for establishing maximum permissible errors (ISO 8655 requirement). A large range of suitable PIPETMAN DIAMOND Tips is available. (See pages 26-29).

** P10N model can be used from 0.5 µL.



The Incarnation of Gilson's Reliability, the World Pipetting Standard!



PIPETMAN Classic is a fully adjustable, air-displacement pipette with the selected volume shown on a digital indicator (volumeter). Designed and manufactured to provide you with a range of robust, accurate and precise pipettes, eight single-channel models cover the full range of volumes from 0.2 µL to 10 mL.

THE STANDARD FOR ROBUSTNESS

- Built to last, constructed of stainless-steel and PVDF (a plastic with very high-resistance to chemical attack).
- P2 and P10 are equipped with dual position tip-ejector (Ref. F144879).

THE STANDARD FOR ACCURACY AND PRECISION

- Unique "dry seal" technology avoids using grease to obtain adequate air-tightness, and guarantees long-term performances.
- Thick body (handle) in PVDF to minimize the hand-warming effect during pipetting.
- Rigorous quality control – each piston is checked using a microscope.
- P5000 and P10mL are safer and more accurate than glass pipettes. They are equipped with a polyethylene filter (Ref. F161241) that prolongs piston life expectancy and prevents contamination.



PIPETMAN Classic is also available in kit!
See page 21 for more information



Trusted results

PIPETMAN Classic's specifications are more stringent than those required to be ISO 8655 compliant.

PIPETMAN Classic Models	PIPETMAN DIAMOND Tips*		Ordering reference	Volume (µL)	Maximum Permissible Errors			
					Gilson		ISO 8655	
					Systematic error (µL)	Random error (µL)	Systematic error (µL)	Random error (µL)
P2	D10 DL10	DF10 DFL10	F144801	0.2	± 0.024	≤ 0.012	± 0.08	≤ 0.04
				0.5	± 0.025	≤ 0.012	± 0.08	≤ 0.04
				1	± 0.025	≤ 0.012	± 0.08	≤ 0.04
				2	± 0.030	≤ 0.014	± 0.08	≤ 0.04
P10	D10 DL10	DF10 DFL10	F144802	1	± 0.025	≤ 0.012	± 0.12	≤ 0.08
				5	± 0.075	≤ 0.030	± 0.12	≤ 0.08
				10	± 0.100	≤ 0.040	± 0.12	≤ 0.08
P20	D200	DF30	F123600	2	± 0.10	≤ 0.030	± 0.2	≤ 0.1
				5	± 0.10	≤ 0.040	± 0.2	≤ 0.1
				10	± 0.10	≤ 0.050	± 0.2	≤ 0.1
				20	± 0.20	≤ 0.060	± 0.2	≤ 0.1
P100	D200	DF100	F123615	20	± 0.35	≤ 0.10	± 0.8	≤ 0.3
				50	± 0.40	≤ 0.12	± 0.8	≤ 0.3
				100	± 0.80	≤ 0.15	± 0.8	≤ 0.3
P200	D200 D300	DF200 DF300	F123601	50	± 0.50	≤ 0.20	± 1.6	≤ 0.6
				100	± 0.80	≤ 0.25	± 1.6	≤ 0.6
				200	± 1.60	≤ 0.30	± 1.6	≤ 0.6
P1000	D1000 D1200	DF1000 DF1200	F123602	200	± 3.0	≤ 0.6	± 8.0	≤ 3.0
				500	± 4.0	≤ 1.0	± 8.0	≤ 3.0
				1000	± 8.0	≤ 1.5	± 8.0	≤ 3.0
P5000	D5000		F123603	1000	± 12	≤ 3	± 40	≤ 15.0
				2000	± 12	≤ 5	± 40	≤ 15.0
				2500	± 15	≤ 5	± 40	≤ 15.0
				5000	± 30	≤ 8	± 40	≤ 15.0
P10mL	D10mL		F161201	1 mL	± 30	≤ 6	± 60	≤ 30.0
				2 mL	± 30	≤ 6	± 60	≤ 30.0
				5 mL	± 40	≤ 10	± 60	≤ 30.0
				10 mL	± 60	≤ 16	± 60	≤ 30.0





pipetman[®] **FIXED**

Big on Reliability, Low on Cost!



PIPETMAN Fixed is an air-displacement pipette, with fixed volume for maximum results and reliability. Fourteen robust models cover a large volume range from 2 μ L to 5000 μ L, with legendary PIPETMAN accuracy and precision.



RIGHT PIPETTE

- GLP compliance – no risk of volume selection errors. Using a dedicated fixed-volume Gilson pipette for a specific test assures reliable and consistent results.

RIGHT PRICE

- An economical choice for clinical diagnostics, quality control, and any routine testing.

RIGHT VOLUME

- Can be readjusted by users in the laboratory, for dense or viscous fluids (once reset the new volume cannot be changed accidentally).

Trusted results

PIPETMAN Fixed's specifications are more stringent than those required to be ISO 8655 compliant.

PIPETMAN F Model	Ordering reference	PIPETMAN DIAMOND Tips*		Volume (μ L)	Maximum Permissible Errors			
					Gilson		ISO 8655	
					Systematic error (μ L)	Random error (μ L)	Systematic error (μ L)	Random error (μ L)
F2	F123770	D200	DF30	2	± 0.08	≤ 0.03	± 0.08	≤ 0.04
F5	F123771	D200	DF30	5	± 0.10	≤ 0.04	± 0.125	≤ 0.075
F10	F123772	D200	DF30	10	± 0.10	≤ 0.05	± 0.12	≤ 0.08
F20	F123604	D200	DF30	20	± 0.20	≤ 0.06	± 0.2	≤ 0.1
F25	F123775	D200	DF30	25	± 0.25	≤ 0.07	± 0.5	≤ 0.2
F50	F123778	D200	DF100	50	± 0.40	≤ 0.15	± 0.5	≤ 0.2
F100	F123784	D200	DF100	100	± 0.80	≤ 0.25	± 0.8	≤ 0.3
F200	F123605	D200 D300	DF200 DF300	200	± 1.60	≤ 0.30	± 1.6	≤ 0.6
F250	F123787	D1000 D1200	DF1000 DF1200	250	± 3.0	≤ 0.75	± 4.0	≤ 1.5
F300	F123788	D1000 D1200	DF1000 DF1200	300	± 3.5	≤ 0.75	± 4.0	≤ 1.5
F400	F123789	D1000 D1200	DF1000 DF1200	400	± 3.6	≤ 0.8	± 4.0	≤ 1.5
F500	F123790	D1000 D1200	DF1000 DF1200	500	± 4.0	≤ 1.0	± 4.0	≤ 1.5
F1000	F123606	D1000 D1200	DF1000 DF1200	1000	± 8.0	≤ 1.3	± 8.0	≤ 3.0
F5000	F123607	D5000		5000	± 30	≤ 8	± 40	≤ 15.0

* Recommended tip for establishing maximum permissible errors (ISO 8655 requirement). A large range of suitable PIPETMAN DIAMOND Tips is available. (See pages 26-29).

- PIPETMAN Classic and Fixed pipettes are available with a calibration certificate issued by an ISO 17025 accredited laboratory, on request. (See pages 44-45).





Lightweight and extremely comfortable, the PIPETMAN M from Gilson is a fully motorized pipette that requires virtually zero pipetting forces to aspirate and dispense samples. Simply turn the push-button to adjust settings and then click!



USE IT LIKE A MECHANICAL PIPETTE

- Keep your technique consistent by using only one button to adjust the volume and to pipette.
- PIPETMAN M is so easy to use that you will have the feeling that you are using a manual pipette.

THE STANDARD FOR ACCURACY AND PRECISION – MOTORIZED

- Designed with both experienced and inexperienced users in mind, PIPETMAN M pipettes are intuitive and require no learning curve to use.
- Motorized piston virtually eliminates pipetting variability among users.
- Adjustable piston speed feature allows users to pipette denser samples with accuracy and confidence.

GLP FEATURES

- Lockable volume.
- Color-coded push-button corresponds to matching TIPACK™.
- Service alert reminders.

EXPANDED FLEXIBILITY

- Four essential pipetting modes – reverse, mix, repetitive and pipet.
- Volume range of 0.5 µL to 1000 µL in only four models.



LONGER USE BETWEEN CHARGE CYCLES

- PIPETMAN M's Lithium-ion battery has been designed to ensure 900 pipetting cycles at maximum speed (up to seven 96 well plates) between charge cycles.
- PIPETMAN M charges 80% of its full battery capacity in less than an hour and takes only three hours to fully charge.

OPTIMIZED BALANCE

- Lightweight, but strong materials and components make PIPETMAN M one of the lightest motorized pipettes ever.

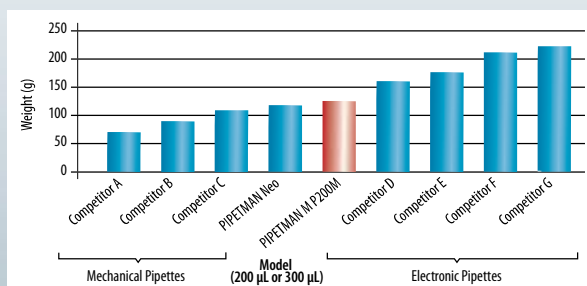

Watch the video!





IMPROVED COMFORT

PIPETMAN M contributes to lowering Repetitive Strain Injuries (RSI):





- Thanks to its motor, PIPETMAN M offers you pipetting with minimized pipetting forces.
- Low ejection and volume setting forces allow you to work longer without fatigue.

Trusted results

Best results guaranteed with a performance exceeding ISO recommendations.

PIPETMAN M helps to avoid variable results between users, thanks to motorized pipetting.

This special feature guarantees highly reproducible results, especially for small volumes.

PIPETMAN M Model	PIPETMAN DIAMOND Tips*		Ordering reference	Volume (µL)	Maximum Permissible Errors			
					Gilson		ISO 8655	
					Systematic error (µL)	Random error (µL)	Systematic error (µL)	Random error (µL)
 P10M	D10 DL10	DF10 DFL10	F81001	0.5	± 0.040	≤ 0.013	± 0.12	≤ 0.08
				1	± 0.025	≤ 0.012	± 0.12	≤ 0.08
				5	± 0.060	≤ 0.020	± 0.12	≤ 0.08
				10	± 0.080	≤ 0.025	± 0.12	≤ 0.08
 P20M	D200 DF30	F81002	2	± 0.075	≤ 0.025	± 0.2	≤ 0.1	
			10	± 0.100	≤ 0.035	± 0.2	≤ 0.1	
			20	± 0.150	≤ 0.050	± 0.2	≤ 0.1	
 P200M	D200 D300	DF200 DF300	F81003	20	± 0.40	≤ 0.15	± 1.6	≤ 0.6
				100	± 0.80	≤ 0.22	± 1.6	≤ 0.6
				200	± 1.00	≤ 0.26	± 1.6	≤ 0.6
 P1000M	D1000 D1200	DF1000 DF1200	F81004	100	± 2.5	≤ 0.4	± 8.0	≤ 3.0
				500	± 3.5	≤ 0.7	± 8.0	≤ 3.0
				1000	± 5.0	≤ 1.1	± 8.0	≤ 3.0

* Recommended tip for establishing maximum permissible errors (ISO 8655 requirement). A large range of suitable PIPETMAN DIAMOND Tips is available. (See pages 26-29).

- PIPETMAN M pipettes are available with a calibration certificate issued by an ISO 17025 accredited laboratory, upon request. (See pages 44-45).

Complete your equipment with:

Safely store and charge your pipette at the same time with the PIPETMAN M Stand Adapter and the Power Carousel (see page 19).

Designed to fit in Gilson's CARROUSEL™ stand and SINGLE™ pipette holder, the adapter allows you to simplify your daily work and organize your bench.



Stand Adapter
(Ref. F807023)





pipetman®



More than a multichannel pipette... it's a PIPETMAN M!



PIPETMAN M Multi is the latest motorized multichannel pipette from Gilson.

PIPETMAN M Multi is the ease of use of PIPETMAN M combined with the well-known advantages of the PIPETMAN Neo multichannel lower part.

Available in 8 and 12 channels, PIPETMAN M Multi is so easy to use that you won't have to change the way you pipette!

INNOVATIVE PATENTED PISTON DRIVE MECHANISM



- The specific rack rail mechanism guarantees identical performance on each channel.
- Thanks to an exclusive patented piston drive mechanism, the pressure is applied consistently and simultaneously on each piston, resolving the common downfall of multichannel pipettes: disparities between channels of the volume distributed.

INGENIOUS TIP EJECTOR TECHNOLOGY

- For more comfort, the ejector spacer has been designed to apply equal ejection forces over each tip sequentially.
- This symmetric system drastically reduces tip ejection forces and risks of RSI.



UNIQUE TIP-HOLDER DESIGN

- Successive rings have been positioned depending on the pipette volume range to guaranty the snug fit of tips throughout the protocols.



Tip-holder

Watch the video!







Trusted results

Best results guaranteed with a performance exceeding ISO recommendations.

PIPETMAN M Multi helps to avoid variable results due to user inexperience, thanks to motorized pipetting.

This special feature guarantees highly reproducible results, especially for small volumes.

PIPETMAN M MULTI Models	PIPETMAN DIAMOND Tips*		Ordering reference	Volume (μL)	Maximum Permissible Errors			
					Gilson		ISO 8655	
					Systematic error (μL)	Random error (μL)	Systematic error (μL)	Random error (μL)
 P8x20M P12x20M	DL10 D200	DFL10 DF30	F81005	1	± 0.08	≤ 0.05	± 0.4	≤ 0.2
				10	± 0.15	≤ 0.10	± 0.4	≤ 0.2
				20	± 0.25	≤ 0.12	± 0.4	≤ 0.2
 P8x200M P12x200M	D200 D300	DF100 DF200 DF300	F81007	20	± 0.50	≤ 0.16	± 3.2	≤ 1.2
				100	± 1.00	≤ 0.30	± 3.2	≤ 1.2
				200	± 2.00	≤ 0.50	± 3.2	≤ 1.2
 P8x300M P12x300M	D200 D300	DF200 DF300	F81011	10	± 1.00	≤ 0.18	± 8.0	≤ 3.0
				30	± 1.00	≤ 0.18	± 8.0	≤ 3.0
				150	± 1.50	≤ 0.375	± 8.0	≤ 3.0
			F81012	300	± 2.40	≤ 0.45	± 8.0	≤ 3.0

* Recommended tip for establishing maximum permissible errors (ISO 8655 requirement). A large range of suitable PIPETMAN DIAMOND Tips is available. (See pages 26-29).

- PIPETMAN M Multi pipettes are available with a calibration certificate issued by an ISO 17025 accredited laboratory, upon request. (See pages 44-45).

power carousel™

PIPETMAN M exclusive charging stand!

This rotating stand, which holds up to 5 PIPETMAN M (single and multichannel), stores and charges your entire pipette set at one time on a minimum bench space!

Protect your PIPETMAN M from shocks and contaminations, and improve your efficiency by keeping your tools always operational!

Ordering reference: FB1001





pipetman **CONCEPT**®



Simply a Click Away From Perfection!



PIPETMAN Concept, a motorized electronic pipette is a combination of tangible quality with high usability and comfort.

Twelve models cover the full range of volumes from 0.5 µL to 10 mL with single and multichannel pipettes for higher productivity and greater comfort.

Five standard pipetting modes cover more than 95% of current application modes: Automatic pipetting, Automatic pipetting + Mixing, Manual, Repetitive, Reverse pipetting.

AMAZINGLY COMFORTABLE OPERATION

- Real ergonomic design of handle and keyboard addresses the users' concern for Repetitive Strain Injuries, backed up by extensive end-user trials.
- The exclusive Gilson Forceless Integrated Tip-ejection System (G-F.I.T. System™) provides instant reliable seals and low ejection forces for Large Volume (C5000, C10mL) and Multichannel models.



SIMPLE "ONE-STEP" COMMAND BUTTONS

- Just click on any of the Mode buttons to access one of five pipetting modes. Click and scroll with the thumbwheel to set the volume, to navigate or to select a menu option.
- Rapidly change the aspirate or dispense speeds (1 to 5) at any moment with the +/- buttons.

CREATE YOUR OWN PIPETTING MODES

- The PC based Utility Software lets you create and store any number of modes on your PC and transfer them to your pipette (PC connection kit, Ref. F30755).
- PIPETMAN Concept's Utility Software allows you to set the maintenance interval (weeks or cycles) and set the alarm that prompts you when it is time to service your pipette. You can store and organize maintenance reports, read data from, export data to your PIPETMAN Concept.















GLP CONCEPT, MAKE NO COMPROMISE ON QUALITY

- Keypad disabled during pipetting.
- Pipette status always on screen.
- Color coding to identify the model and corresponding PIPETMAN DIAMOND® Tip range.
- Color-coded ID Tags to write your name or application.
- User-defined stand-by screen text.



Trusted results

PIPETMAN Concept's specifications are more stringent than those required to be ISO 8655 compliant.

	PIPETMAN Concept Model w/o AC-adapter (volume range)	Ordering reference	PIPETMAN DIAMOND Tips*		Tested Volume (μL)	Maximum Permissible Errors			
						Gilson		ISO 8655	
						Systematic error (μL)	Random error (μL)	Systematic error (μL)	Random error (μL)
SINGLE CHANNEL MODELS	 C10 (0.5 - 10 μL)	F31012	D10 DL10	DFL10	Min.: 0.5 1 5 Max.: 10	± 0.040 ± 0.025 ± 0.060 ± 0.080	≤ 0.013 ≤ 0.012 ≤ 0.020 ≤ 0.025	± 0.12 ± 0.12 ± 0.12 ± 0.12	≤ 0.08 ≤ 0.08 ≤ 0.08 ≤ 0.08
	 C100 (5 - 100 μL)	F31013	D200	DF100	Min.: 5 10 50 Max.: 100	± 0.35 ± 0.30 ± 0.38 ± 0.40	≤ 0.10 ≤ 0.10 ≤ 0.12 ≤ 0.15	± 0.8 ± 0.8 ± 0.8 ± 0.8	≤ 0.3 ≤ 0.3 ≤ 0.3 ≤ 0.3
	 C300 (20 - 300 μL)	F31014	D200 D300	DF200 DF300	Min.: 20 30 150 Max.: 300	± 0.80 ± 0.70 ± 0.90 ± 1.05	≤ 0.16 ≤ 0.20 ≤ 0.23 ≤ 0.30	± 4.0 ± 4.0 ± 4.0 ± 4.0	≤ 1.5 ≤ 1.5 ≤ 1.5 ≤ 1.5
	 C1200 (100 - 1200 μL)	F31015	D1200	DF1200	Min.: 100 120 600 Max.: 1200	± 2.5 ± 2.4 ± 3.6 ± 3.6	≤ 0.4 ≤ 0.4 ≤ 0.8 ≤ 1.2	± 16 ± 16 ± 16 ± 16	≤ 6.0 ≤ 6.0 ≤ 6.0 ≤ 6.0
	 C5000 (500 - 5000 μL)	F31016	D5000		Min.: 500 2500 Max.: 5000	± 10 ± 15 ± 25	≤ 2 ≤ 4 ≤ 7	± 40 ± 40 ± 40	≤ 15.0 ≤ 15.0 ≤ 15.0
	 C10mL (1 - 10 mL)	F31017	D10mL		Min.: 1mL 5mL Max.: 10mL	± 25 ± 30 ± 50	≤ 4 ≤ 8 ≤ 12	± 60 ± 60 ± 60	≤ 30.0 ≤ 30.0 ≤ 30.0
MULTICHANNEL MODELS	 8x10 (0.5 - 10 μL)	F31032	DL10	DFL10	Min.: 1 5 Max.: 10	± 0.04 ± 0.08 ± 0.10	≤ 0.02 ≤ 0.04 ≤ 0.06	± 0.24 ± 0.24 ± 0.24	≤ 0.16 ≤ 0.16 ≤ 0.16
	 12x10 (0.5 - 10 μL)	F31042	DL10	DFL10	Min.: 1 5 Max.: 10	± 0.04 ± 0.08 ± 0.10	≤ 0.02 ≤ 0.04 ≤ 0.06	± 0.24 ± 0.24 ± 0.24	≤ 0.16 ≤ 0.16 ≤ 0.16
	 8x100 (5 - 100 μL)	F31033	D200	DF100	Min.: 10 50 Max.: 100	± 0.25 ± 0.50 ± 0.80	≤ 0.14 ≤ 0.20 ≤ 0.25	± 1.6 ± 1.6 ± 1.6	≤ 0.6 ≤ 0.6 ≤ 0.6
	 12x100 (5 - 100 μL)	F31043	D200	DF100	Min.: 10 50 Max.: 100	± 0.25 ± 0.50 ± 0.80	≤ 0.14 ≤ 0.20 ≤ 0.25	± 1.6 ± 1.6 ± 1.6	≤ 0.6 ≤ 0.6 ≤ 0.6
	 8x300 (20 - 300 μL)	F31034	D200 D300	DF200 DF300	Min.: 30 150 Max.: 300	± 1.00 ± 1.50 ± 2.40	≤ 0.18 ≤ 0.38 ≤ 0.60	± 8.0 ± 8.0 ± 8.0	≤ 3.0 ≤ 3.0 ≤ 3.0
	 12x300 (20 - 300 μL)	F31044	D200 D300	DF200 DF300	Min.: 30 150 Max.: 300	± 1.00 ± 1.50 ± 2.40	≤ 0.18 ≤ 0.38 ≤ 0.60	± 8.0 ± 8.0 ± 8.0	≤ 3.0 ≤ 3.0 ≤ 3.0

* Recommended tip for establishing maximum permissible errors (ISO 8655 requirement). A large range of suitable PIPETMAN DIAMOND Tips is available. (See pages 26-29).

Complete your equipment with:

Accessories	Ordering reference
Power Supply 5V multi plug	F30705
Battery block	F3071165
Rapid Charge Stand	F30750
PC connection Kit (including Utility Software*)	F30755
PIPETMAN Concept Utility Software	F3075502
Name Tags	F3071107

*This product and/or its use in certain methods is/are subject of patent rights including US patent #6.778.917, owned by EPPENDORF AG.

PIPETMAN Concept always ready-to-use...



... on the rapid charge stand
... using the power supply
... using the additional Li-ion battery block



 • PIPETMAN Concept Single and Multichannel pipettes are available with a calibration certificate issued by an ISO 17025 accredited laboratory, on request. (See pages 44-45).



pipetmax[®]

Gilson takes PIPETMAN to the MAX!

Manual sample preparation can often be inefficient, complex and time-consuming. This leads to increased training requirements, preparation time, procedural errors and operational costs. PIPETMAX, from Gilson, is an easy-to-use, automated liquid handling platform that can solve these problems with automated sample preparation solutions. Unlike traditional automation platforms, PIPETMAX comes at a size and price that is accessible to any lab, and has a PIPETMAN inside!



MAXIMIZE EFFICIENCY

The easy-to-use PIPETMAX takes the tedious work of pipetting out of your hands, freeing you to do other important projects.

MAXIMIZE YOUR ROI

PIPETMAX can decrease your training expenses and pipetting errors. Benefit from automating routine processes with a small investment.

MAXIMIZE RESULTS

The trusted PIPETMAN[®] - built-in reliability for consistent results. The most reliable pipette inside the most reliable automated pipette system.

MAXIMIZE LAB SPACE

A small footprint that fits easily on your benchtop or under a hood.

MAXIMIZE YOUR REAGENTS

Flexible, open platform allows you to use your favorite reagents.

MAXIMIZE YOUR OPTIONS

Download applications with simple protocol configurations on an intuitive, open software platform we've designed with your needs in mind.

1 No More User Variation

Free yourself from tedious pipetting jobs and free your results from inconsistencies due to pipetting errors.

2 A Technology You Can Trust... PIPETMAN Built Inside!

With PIPETMAN built inside PIPETMAX, you can trust your pipetting to be reliable and consistent, plate to plate, lot to lot, time after time.

3 A Truly Open System! Use any Reagent, any Protocol

Configure and customize your run using any reagent and any protocol you want. The hardware and software are built to be customizable.

4 Designed to Perform Common Pipetting Tasks and Protocols

Download pre-developed, validated protocols with simple configurations.

5 Small Footprint

Fits under a hood or at your benchtop for maximum convenience. Weighs just under 40 pounds, so moving it is quick and easy too!

6 Exchangeable Pipetting Heads and Removeable Tray

Hardware can be customized to fit your needs and the pipetting heads can be calibrated just like a PIPETMAN!



Watch the video!



Download pre-developed protocols to automate common processes like qPCR and NGS sample preparation.

Use the Protocol Builder software to create and edit protocols on your own



Configure and run protocols through a simple touchscreen interface



Run your lab with the precision and ease of training-free automation



Pipette Kits

All You Need to Get Started, in a Single Box!

Our pipette kits include the PIPETMAN Classic™, PIPETMAN Neo® & PIPETMAN® G ranges for all of your pipetting needs.

ALL IN ONE SAVINGS

- Each kit contains two or three PIPETMAN Classic or PIPETMAN Neo or PIPETMAN G models plus racks or tipack of certified-quality PIPETMAN DIAMOND™ Tips and useful accessories, such as SINGLE™ Pipette Holders (except Large Volume Kit).
- Save money when compared to pipettes and accessories bought separately.



Model	Ordering reference	PIPETMAN models	PIPETMAN DIAMOND Tips (racks of 96 tips)	Accessories	
PIPETMAN G Starter Kit	F167900	P20G* P200G* P1000G*	D200 D1000	<ul style="list-style-type: none"> • 3 SINGLE™ pipette holders • 10 COLORIS™ identification clips • 1 Gilson Guide to Pipetting • 3 plastic ejectors 	
PIPETMAN G Micro-Volume Kit	F167800	P2G* P10G* P100G*	DFL10ST DF100ST	<ul style="list-style-type: none"> • 3 SINGLE pipette holders • 10 COLORIS identification clips • 1 Gilson Guide to Pipetting • 3 plastics ejectors 	
PIPETMAN Neo PCR Kit	F167600	P10N P100N P1000N	DFL10ST DF100ST DF1000ST	<ul style="list-style-type: none"> • 3 SINGLE pipette holders • 3 microtube openers THE JIMMY™ • 1 Gilson Guide to Pipetting • 1 Two-minute inspection poster • 3 pipette identification stickers 	
PIPETMAN Neo Starter Kit	F167700	P20N P200N P1000N	D200 D1000	<ul style="list-style-type: none"> • 3 SINGLE pipette holders • 3 microtube openers THE JIMMY • 1 Gilson Guide to Pipetting • 1 Two-minute inspection poster • 3 pipette identification stickers 	
PIPETMAN Classic Micro-Volume Kit	F167500	P2 P10 P100	DFL10ST DF100ST	<ul style="list-style-type: none"> • 3 SINGLE Pipette Holders • 10 COLORIS identification clips • 1 Gilson Guide to Pipetting 	
PIPETMAN Classic Starter Kit	F167300	P20 P200 P1000	D200 D1000	<ul style="list-style-type: none"> • 3 SINGLE Pipette Holders • 10 COLORIS identification clips • 1 Gilson Guide to Pipetting 	
PIPETMAN Classic Large-Volume Kit	F167400	P5000 P10mL	-	<ul style="list-style-type: none"> • 2 x 10 protection filters for P5000 and P10mL 	

* Pipettes are equipped of stainless steel ejectors.



Pipette Accessories

The perfect addition to your PIPETMAN®!

Gilson accessories are of the same high quality as Gilson pipettes. Gilson considers accessories as a part of the pipetting system. All pipettes should be stored vertically to avoid the possibility of liquid running back into, and contaminating or corroding the interior of the pipette.

CARROUSEL™ PIPETTE STAND

The CARROUSEL holds up to seven Gilson pipettes, all models (except PIPETMAN Concept®). Its rotating head provides easy access to the desired unit. CARROUSEL is robust, stable and space saving, making your work bench look neat. Its heavy base prevents toppling over.



SINGLE™ PIPETTE HOLDER

SINGLE is designed to conveniently hold all Gilson Pipettes (except PIPETMAN Concept) where space is limited (fume hoods, bio safety cabinets, etc.). Stuck to any smooth, dry surface or fastened with screws, it keeps your pipette within reach. Resistant to chemicals and UV light.



TRIO™ PIPETTE STAND

The new TRIO stand features enhanced quality and reliability. Its angled, transparent design provides a convenient and secure way to store your Gilson pipettes (any models except PIPETMAN Concept) with exceptional stability. Its transparent body allows you to see the objects placed behind.



UNIVERSAL MULTICHANNEL STAND

The Universal multichannel stand is a dedicated stand for all multichannel pipettes (8 or 12 channels of any brands). It protects and stores your pipette on a minimized bench space.



GILSON REAGENT RESERVOIRS

Disposable reagent reservoirs, constructed of white polystyrene, are ideal for dispensing reagent with multichannel pipettes. Two different types are available, 25 mL and 50 mL.



CORROSION PROTECTION KIT

The Corrosion protection kit, composed of a specific tip-holder and its filters, is the ideal protection for your PIPETMAN P1000, PIPETMAN Neo P1000N & PIPETMAN F1000 while pipetting corrosive liquids, such as acids.



NAME TAGS

Personalize your PIPETMAN Concept and PIPETMAN L by writing your name and application on one of the colored stickers (protected by the plastic window).



COLORIS™ IDENTIFICATION CLIPS













GLP-friendly, these brightly colored clips are used to identify or personalize your PIPETMAN pipettes. Just write your name or application to avoid mix-ups. Made of polyacetal, COLORIS clips accept permanent ink and just snap into place.



THE JIMMY™ MICROTUBE OPENER

PIPETMAN® ergonomic and hands-free microtube opener, opens both snap-cap and screw-cap tubes. This effective device eliminates the need to manually handle the caps of tubes when opening. It increases pipetting efficiency and lessens the fatigue associated with manual tube opening.



Description	Ordering reference
 CARROUSEL, stand for 7 pipettes	F161401
 SINGLE pipette holder	F161406
 TRIO, stand for 3 pipettes	F161405
 Universal Multichannel Stand	F161417
 Reagent Reservoir 25mL, 10 packs of 10 reservoirs	F267660
 Reagent Reservoir 50mL, 10 packs of 10 reservoirs	F267670
 Corrosion Protection Kit	F144570
 Corrosion Protection Kit Filter - Bag of 10	F144571
 Corrosion Protection Kit Filter - Bag of 50	F144572
 Set of 6 name tags, PIPETMAN L	FA07082
 Set of 5 name tags, PIPETMAN Concept	F3071107
 10 COLORIS clips, mixed colours, PIPETMAN	F161301
 10 COLORIS clips, red, PIPETMAN	F161302
 10 COLORIS clips, yellow, PIPETMAN	F161303
 10 COLORIS clips, green, PIPETMAN	F161304
 10 COLORIS clips, blue, PIPETMAN	F161305
 10 COLORIS clips, white, PIPETMAN	F161306
 THE JIMMY, microtube opener	F144983



Your protocols and experiments require more than just generic pipette tips. Accuracy and precision of your pipetting system is directly linked to the performance delivered by the pipette-tip combination. Tips are essential components of your pipetting system. By not using recommended tips, you put your results at risk.

Fully traceable from the mold to your laboratory bench.

Prevent sample and pipette contamination with PIPETMAN DIAMOND filter tips

Pure polypropylene ensures no contamination and complete dispensing.

No contamination. Sterilized PIPETMAN DIAMOND Tips are free of biological contaminants with a SAL of 10⁻⁶

Genuine Gilson PIPETMAN DIAMOND® Tip. PIPETMAN specifications are valid only with the use of PIPETMAN DIAMOND Tips.

Perfect airtight seal ensures no leak.

Volume graduations make it easy to visually check the volume pipetted.

Best match between pipette and tip reduces the strain to fit & eject tips.

Finepoint PIPETMAN DIAMOND Tip geometry delivers maximum accuracy.

A large choice of packaging

Your needs, budget and tip consumption vary according to your activity. Gilson offers one of the largest ranges of packaging from large quantity bulk tips to an innovative refill system to satisfy virtually all requirements.

TOWERPACK™, THE INNOVATIVE REFILL SYSTEM

- Discover a quick and easy rack refill at an affordable price.
- Use 60% less space on your bench and 70% less plastic.



BAGS, THE ECONOMICAL SOLUTION

- Available in convenient small bags or in economical bulk quantities, bags are available in 2 formats:
EcoPack = 10 bags of 1,000 tips
EasyPack = 5 bags of 200 tips
- All bulk bags are sealed with a sealing strip at the top. This seal can be easily torn off the bag to access the resealable zipper which keeps the tips secure within the bag.



TIPACK™

Engineered to be functional, convenient and robust.

- TIPACKS are securely sealed with a sticker. A full product description is given on the TIPACK for traceability and easy identification.
- Robust and designed to withstand autoclaving.



The patented ROCKY RACK™ system available on TOWERPACK™ and TIPACK™ makes it extremely easy to fit tips on a multi-channel pipette. Tips will not fall off nor will they have to be manually positioned.



Superior Accuracy and Precision guaranteed

“The maximum permissible errors always apply to the total system of piston, pipette and tip. When using pipette tips not delivered by the pipette supplier, the supplier’s declaration or certificate of conformity does not apply” (ISO 8655-2)*.

**ISO 8655 is an international standard for “piston operated apparatus”. ISO 8655 defines, among other things, terms and definitions regarding piston operated pipettes and their testing, testing procedure and maximum permissible errors.*

Evaluation of the influence of different tip brands of comparable quality (A, B,...I) on the accuracy and precision of a PIPETMAN® P10 at 1 µL.

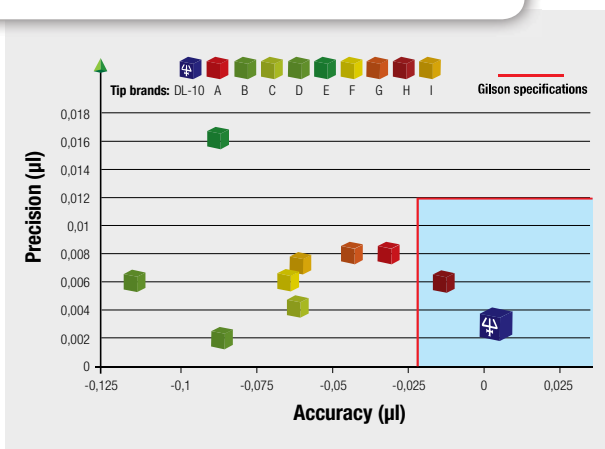

Results obtained in the Gilson ISO 17025 COFRAC accredited laboratory from 10 measurements of 1 µL of water at 21°C using a PIPETMAN P10.

PIPETMAN DIAMOND certified tips assure optimal performance of your PIPETMAN pipette. The only way to ensure precision and reproducibility across the full volume range is to use PIPETMAN DIAMOND precision tips with PIPETMAN.

TRACE METAL RELEASE

- A certificate giving evidence of the low level of potential contamination can be downloaded from our website.

STERILIZED TIPS

- Sterility assurance level SAL 10⁻⁶ guaranteed, using gamma irradiation.
- All packs are wrapped in medical device quality plastic which provides a complete shield against contamination.
- Indicator dots used on Gilson products undergo an irreversible color change upon sterilization. Yellow gamma dots turn red when products have been properly exposed.
- Free of detectable RNases, DNases, DNA, RNA, ATP and Pyrogen.
- Regular analysis carried out by an independent laboratory.
- Certificate of compliance with detailed protocols and detection levels for each batch.

PIPETMAN DIAMOND TIP GEOMETRY DELIVERS MAXIMUM ACCURACY

- PIPETMAN DIAMOND Tips guarantee that Gilson pipettes meet our specified tolerances and deliver consistent results over time.

ADDING COMFORT WHILE FITTING AND EJECTING TIPS

- Loose tip fitting is a major cause of poor performance. Specifically designed for the Gilson pipettes, the diameter of the tip-collar and tip-holder of the PIPETMAN DIAMOND Tips are calculated to fit together perfectly.

BEST MATCH BETWEEN PIPETTE AND TIPS REDUCES THE STRAIN TO FIT & EJECT TIPS

- With PIPETMAN DIAMOND Tips no need to jam them on “extra tight” – use of excessive force that causes muscular stress and fatigue to the arm and shoulder is greatly reduced. As a result, thumb force to eject tips is minimal.

PURE POLYPROPYLENE ENSURES NO CONTAMINATION AND COMPLETE DISPENSING

- PIPETMAN DIAMOND Tips are made from the highest grade virgin polypropylene to prevent contamination of your experiments. This polypropylene has high hydrophobic properties to ensure the lowest possible retention no matter what liquid is pipetted.



ENVIRONMENTAL POLICY



Gilson is concerned about disposal of plastics into the environment and knows that most of our end users also feel responsible. The company has taken a number of initiatives to minimize the impact of tip-packaging waste and has notably designed an original reload system (TOWERPACK™) which uses 70% less plastic than racks.

All plastic parts and cardboard packaging are recyclable and marked with the recycling logo.





Pipette tips are actual size except D5000 and D10mL.

	Volume range	Tip model	PIPE				
			Classic	Neo	Fixed	G	
STANDARD TIPS	0.1 - 10 µL	D10	P2, P10	P2N, P10N	-	P2G, P10G	
	0.1 - 20 µL	DL10	P2, P10	P2N, P10N		P2G, P10G	
	2 - 200 µL	D200	P20 to P200	P20N to P200N, 8x200, 12x200	F2 to F200	P20G to P200G	
	20 - 300 µL	D300	P200	P200N, 8x200, 12x200	F200	P200G	
	100 - 1000 µL	D1000	P1000	P1000N	F250 to F1000	P1000G	
	100 - 1200 µL	D1200	P1000	P1000N	F250 to F1000	P1000G	
	0.5 - 5 mL <i>Scale 1/2</i>	D5000	P5000	-	F5000	P5000G	
	1 - 10 mL <i>Scale 1/2</i>	D10mL	P10mL	-	-	P10mL G	
	FILTER TIPS	0.1 - 10 µL	DF10	P2, P10	P2N, P10N	-	P2G, P10G
		0.1 - 10 µL	DFL10	P2, P10	P2N, P10N 8x20, 12x20		P2G, P10G
2 - 30 µL		DF30	P20	P20N 8x20, 12x20	F2 to F25	P20G	
20 - 100 µL		DF100	P100	P100N	F50 to F100	P100G	
20 - 200 µL		DF200	P200	P200N, 8x200, 12x200	F200	P200G	
20 - 300 µL		DF300	P200	P200N, 8x200, 12x200	F200	P200G	
100 - 1000 µL		DF1000	P1000	P1000N	F250 to F1000	P1000G	
100 - 1200 µL		DF1200	P1000	P1000N	F250 to F1000	P1000G	

D5000 and D10mL shown to scale.



D5000



D10mL



PIPETMAN			TIPACK PIPETMAN DIAMOND Tips (10 TIPACKS of 96 racked tips)		TOWERPACK refill system for PIPETMAN DIAMOND Tips (10 racks of 96 tips)		STERILPACK (400 tips individually wrapped)	ECOPACK box of 10,000 tips (10 bags of 1,000)	EASYPACK box of 1,000 tips (5 bags of 200)	Empty Racks (set of 2)
L	M	Concept	Autoclavable	γ-Ray sterilized	Autoclavable	γ-Ray sterilized				
F1L, F2L, F5L, F10L P2L, P10L 8x10L, 12x10L	P10M	C10	F171100	F171101	F167101	F167201	-	F161630	F161631	F171102
F1L, F2L, F5L, F10L P2L, P10L 8x10L, 12x10L, 8x20L, 12x20L	P10M, 8x20, 12x20	C10, 8x10, 12x10	F171200	F171201	F167102	F167202	-	F161450	F161451	F171202
F20L, F25L, F50L, F100L, F200L P20L to P200L 8x20L, 12x20L, 8x200L, 12x200L	P20M, P200M, 8x20, 12x20, 8x200, 12x200	C100, C300, 8x100, 12x100, 8x300, 12x300	F171300	F171301	F167103	F167203	F161330	F161930	F161931	F171302
F250L P200L 8x200L, 12x200L, 8x300L, 12x300L	P200M, 8x200, 12x200 8x300, 12x300	C300, 8x300, 12x300	F171400	F171401	F167105	F167205	-	F161730	F161731	F171402
F300L, F400L, F500L, F1000L P1000L	P1000M	-	F171500	F171501	F167104 (7 racks of 96 tips)	F167204 (7 racks of 96 tips)	F161340	F161670	F161671	F171502
P1000L	P1000M	C1200	F171600	F171601	-	-	-	F161110	F161111	F171502
F5000L P5000L	-	C5000	F161370 (12 TIPACKS of 50 tips)	-	-	-	-	-	F161571 (3 bags of 334 tips)	F161360 (1 rack)
P10mL L	-	C10mL	F161230 (8 TIPACKS of 30 tips)	-	-	-	-	-	F161210 (200 tips)	F161220 (1 rack)
F1L, F2L, F5L, F10L P2L, P10L	P10M	-	-	F171103						
F1L, F2L, F5L, F10L P2L, P10L 8x10L, 12x10L	P10M, 8x20, 12x20	C10, 8x10, 12x10	-	F171203						
F20L, F25L P20L 8x10L, 12x10L, 8x20L, 12x20L	P20M, 8x20, 12x20	-	-	F171303						
F50L, F100L P100L 8x200L, 12x200L	8x200, 12x200	C100, 8x100, 12x100	-	F171403						
F200L P200L 8x200L, 12x200L	P200M, 8x200, 12x200	C300, 8x300, 12x300	-	F171503						
F250L P200L 8x200L, 12x200L, 8x300L, 12x300L	P200M, 8x200, 12x200 8x300, 12x300	C300, 8x300, 12x300	-	F171603						
F300L, F400L, F500L, F1000L P1000L	P1000M	-	-	F171703						
P1000L	P1000M	C1200	-	F171803						



Item: Universal reload box
Ordering reference: F167100



DON'T FORGET!
PIPETMAN DIAMOND Tips are also compatible with many other popular pipette brands. Contact your local distributor for more information on PIPETMAN DIAMOND Tips.





trackman™

Guiding You To Success!



Get on track, keep on track, as you pipette flawlessly with the help of your new personal laboratory assistant. TRACKMAN simplifies your work, improves your productivity and helps eliminate errors and cross-contamination.

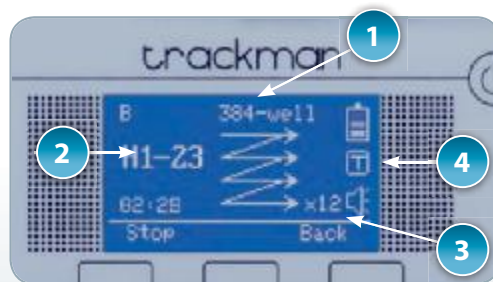

INTUITIVE SOFTWARE INTERFACE

- 1 Plate types (96 or 384 wells or microtubes)
- 2 Indicator of well or tube position
- 3 Pipette types (1, 8 or 12 channels)
- 4 Timer function or manual

Watch the video!



16 PROGRAMMING POSSIBILITIES FOR A VARIETY OF APPLICATIONS

Different pipetting patterns, (individually through rows, columns or other configurations), different pipette types and vessel types!



MAXIMUM CONTROL

- 16 programming possibilities for pipetting patterns (rows, columns, etc.), pipette types and plate types.
- Timer function enables hands-free operation.
- Optional foot pedal available for hands free control.

VERSATILE PERFORMANCE

- Duo-plate tracker lights the way to your pipetting so you avoid losing track of where you need to start or where you left off.
- Can be used with both 96 and 384 well microplates, and single and multichannel pipettes.
- Easily switch from using one size plate to another on the same instrument.

ALWAYS OPERATIONAL

- Long lasting battery allows cordless operation for up to eight hours.
- Portable slim design takes up small footprint on your benchtop.

CONTEMPORARY DESIGN

- Light-weight and ergonomic.
- Use with 0.5, 1.5 and 2.0 mL tubes with the optional tube holder accessory.
- Optimal positioning.



Model	Ordering reference
TRACKMAN	F70301



Complete your equipment with:

Microtube-holder: Ref. F70105

Expand the functionality of your TRACKMAN with the versatile microtube-holder to transfer liquids from one microtube to another (0.5 mL, 1.5 mL and 2 mL).

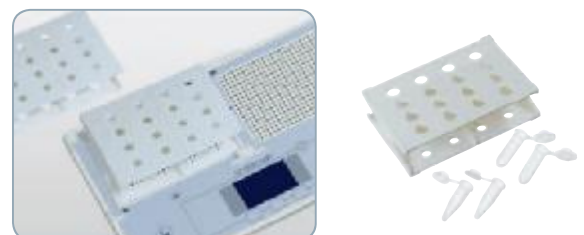

Pedal for TRACKMAN: Ref. F70261

Enjoy hands-free operating and individual speed control, when you equip your TRACKMAN with Gilson's optional foot pedal.





microman[®]

The Pipette of Choice for Problem Liquids!



How does a positive-displacement pipette work?

1. No air-to-liquid interface
2. The desired volume is aspirated rapidly and completely
3. The positive wiping action of the piston against the capillary wall assures accurate dispensing of even the most viscous sample and avoids any carry-over

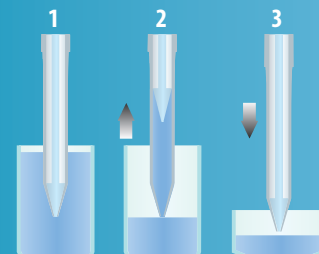

IMPROVE ACCURACY AND RELIABILITY WITH PROBLEM LIQUIDS

- Perfect solution for complete and rapid pipetting of viscous and dense liquids such as oil, syrup, cosmetic cream, liquefied food, paint, glycerol or buffers.
- Unique solution to avoid leakage when pipetting high vapor pressure liquids such as acetone, chloroform, alcohol, hexane or solvents.





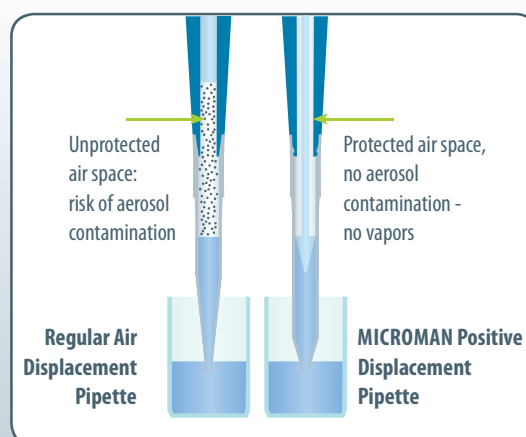
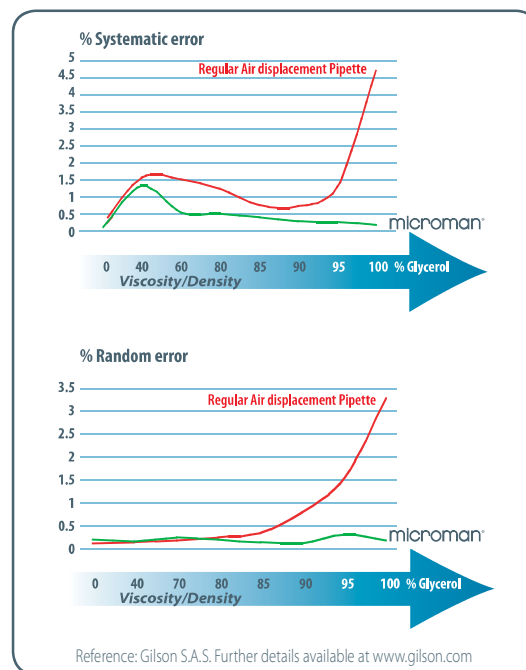

100% PROTECTION AGAINST CONTAMINATION

- Disposable capillaries and pistons prevent contact of the pipette with corrosive vapors or liquids.
- Built-in tip ejector prevents user contamination.
- No air-to-liquid interface protects the sample from aerosol contamination.
- Contamination-free pipetting of liquids such as DNA fragments, PCR templates, enzyme solutions or radio labeled components.



Trusted results

MICROMAN's specifications are more stringent than those required to be ISO 8655 compliant.

MICROMAN Model	Ordering reference	Capillary Piston	Volume (μL)	Maximum Permissible Errors			
				Gilson		ISO 8655	
				Systematic error (μL)	Random error (μL)	Systematic error (μL)	Random error (μL)
 M10	F148501	CP10	Min.: 1 5 Max.: 10	± 0.09 ± 0.10 ± 0.15	≤ 0.03 ≤ 0.03 ≤ 0.06	± 0.2 ± 0.2 ± 0.2	≤ 0.1 ≤ 0.1 ≤ 0.1
 M25	F148502	CP25	Min.: 3 10 Max.: 25	± 0.25 ± 0.27 ± 0.30	≤ 0.08 ≤ 0.08 ≤ 0.10	± 0.7 ± 0.7 ± 0.7	≤ 0.3 ≤ 0.3 ≤ 0.3
 M50	F148503	CP50	Min.: 20 Max.: 50	± 0.34 ± 0.70	≤ 0.20 ≤ 0.30	± 0.7 ± 0.7	≤ 0.3 ≤ 0.3
 M100	F148504	CP100	Min.: 10 50 Max.: 100	± 0.50 ± 0.75 ± 1.00	≤ 0.20 ≤ 0.30 ≤ 0.40	± 1.5 ± 1.5 ± 1.5	≤ 0.6 ≤ 0.6 ≤ 0.6
 M250	F148505	CP250	Min.: 50 100 Max.: 250	± 1.50 ± 1.70 ± 2.50	≤ 0.30 ≤ 0.30 ≤ 0.50	± 6 ± 6 ± 6	≤ 2.0 ≤ 2.0 ≤ 2.0
 M1000	F148506	CP1000	Min.: 100 500 Max.: 1000	± 3.0 ± 5.0 ± 8.0	≤ 1.6 ≤ 2.5 ≤ 4.0	± 12 ± 12 ± 12	≤ 4.0 ≤ 4.0 ≤ 4.0

 MICROMAN Pipettes are available with a calibration certificate issued by an ISO 17025 accredited laboratory (See pages 44-45).

microman® 



MICROMAN and Capillary Pistons (CP)

- Large volume range from 1 μL to 1000 μL with six different models.
- No need for calibration when you change the CP.
- Continuous volume adjustment and direct digital display.
- Disposable CP, capillaries made of pure polypropylene.
- Free of dyes, no risk of contamination from the CP's components.
- Slim CP fits in even the narrowest and deepest tubes.

MICROMAN model	Related CP	Volume range (μL)	Ordering reference	Quantity per box	Available in TIPACK
M10	CP10	1 - 10	F148412	192	✓
	CP10		F148312	960	✓
	CP10ST*		F148413	192	✓
	CP10ST*		F148313	960	✓
M25	CP25	3 - 25	F148012	960	✓
			F148112	200	-
M50	CP50	20 - 50	F148013	960	✓
			F148113	200	-
M100	CP100	10 - 100	F148414	192	✓
	CP100		F148314	960	✓
	CP100ST*		F148415	192	✓
	CP100ST*		F148315	960	✓
M250	CP250	50 - 250	F148014	960	✓
			F148114	200	-
M1000	CP1000	100 - 1000	F148560	182	✓
	CP1000ST*		F148180	182	✓

*ST = Sterilized



distriman®

The Simplicity of a Continuously Adjustable Repeater-Pipette!



DISTRIMAN is a positive-displacement, continuously adjustable repeater-pipette to simplify multiple dispensing when used with Gilson DISTRITIP syringes.

DISTRIMAN Ordering reference

F164001

DIRECT VOLUME READOUT

- With the DISTRIMAN you can dispense the exact volume, eliminating tedious calculations.

ONLY 3 SYRINGES ARE NEEDED

- Micro 125 μ L, Mini 1250 μ L and Maxi 12.5 mL cover the entire volume range (aliquots from 1 μ L to 1.25 mL).
- DISTRIMAN is the only repetitive pipette available capable of dispensing more than 100 aliquots.

WIDE SELECTION OF PACKAGING OPTIONS

- Each model of DISTRITIPS is available in standard or sterilized (ST) version, in boxes of 50 syringes.
- Sterilized DISTRITIPS are individually wrapped and certified free of RNase, DNase, DNA, RNA, ATP, and pyrogens.



distritips®



Trusted results

DISTRIMAN's specifications are more stringent than those required to be ISO 8655 compliant.

DISTRITIPS (box of 50 syringes)	Aliquot Range	Ordering reference	Volume (μ L)	Maximum Permissible Errors			
				Gilson		ISO 8655	
				Systematic error (μ L)	Random error (μ L)	Systematic error (μ L)	Random error (μ L)
125 μL Micro Micro ST*	1 μ L to 12.5 μ L	F164100 F164130	Min. 2	± 0.100	≤ 0.080	± 0.2	≤ 0.1
			5	± 0.125	≤ 0.075	± 0.2	≤ 0.1
			Max. 10	± 0.200	≤ 0.100	± 0.2	≤ 0.1
1250 μL Mini Mini ST*	10 μ L to 125 μ L	F164110 F164140	Min. 20	± 0.80	≤ 0.20	± 1.5	≤ 0.6
			50	± 1.00	≤ 0.40	± 1.5	≤ 0.6
			Max. 100	± 1.00	≤ 0.60	± 1.5	≤ 0.6
12.5 mL Maxi Maxi ST*	100 μ L to 1.25 mL	F164120 F164150	Min. 200	± 6.0	≤ 1.0	± 12.0	≤ 4.0
			500	± 7.5	≤ 1.5	± 12.0	≤ 4.0
			Max. 1000	± 10.0	≤ 2.5	± 12.0	≤ 4.0

*ST means sterilized syringes (individually wrapped).





repetman®

The Motorized Repetitive Dispensing Solution!



HIGH PERFORMANCE

- Wide range of dispensed volume. From 1 μ L to 50 mL including non-standard such as 7.5 μ L, 156 μ L or 9.54 mL.
- Simple and intuitive operation. Three operating modes: Dispensing, Automatic Dispensing and Pipetting.
- Perfect match with REPET-TIPs to meet ISO's recommendations.
- Also compatible with most standard syringe tips commonly used in the market such as: Brand PD-Tip™, Eppendorf®, Combitips® plus, etc.
- Rechargeable battery pack. Automatic battery recharging by placing REPETMAN on the charging stand.
- A second battery pack can be charged directly on the stand.



COMFORTABLE

- Ergonomic design. Fits naturally in either hand and increases operator comfort.
- Automatic tip identification. Coded syringe-plunger automatically identifies the tip size.
- Learn function. Digital pipetting-rate monitoring technology detects your true pipetting-rate and then automatically adjusts dispensing rhythm.

REPETMAN*	Ordering reference
REPETMAN, EU plug (230V / 50Hz)	F164501
REPETMAN, US plug (110V / 50-60Hz)	F164502
REPETMAN, UK plug (230V / 50Hz)	F164503
REPETMAN, Australian plug (240V / 50Hz)	F164504
NiMH battery pack	F164595

*Currently not available in the US and Canada

repet-tips

LARGE CHOICE OF REPET-TIP PACKAGING

- Ten standard or sterile REPET-TIP syringe sizes available from 0.1 mL to 50 mL.
- Sterile REPET-TIPs are individually wrapped and certified free of endotoxins.



REPET-TIPS	Non-sterile	Sterile*
REPET-TIP (0.1 mL, box of 100)	F164510	F164515
REPET-TIP (0.5 mL, box of 100)	F164520	F164525
REPET-TIP (1.0 mL, box of 100)	F164527	F164528
REPET-TIP (1.25 mL, box of 100)	F164530	F164535
REPET-TIP (2.5 mL, box of 100)	F164540	F164545
REPET-TIP (5.0 mL, box of 100)	F164550	F164555
REPET-TIP (10.0 mL, box of 100)	F164557	F164558
REPET-TIP (12.5 mL, box of 100)	F164560	F164565
REPET-TIP (25 mL, box of 50)**	F164570	-
REPET-TIP (25 mL, box of 25)**	-	F164575
REPET-TIP (50 mL, box of 25)**	F164580	F164585
Adapter for 25/50 mL REPET-TIP (set of 10)	F164591	-
Adapter for 25/50 mL REPET-TIP (set of 5)	-	F164592

* Sterile / Endotoxin-free ** One autoclavable adapter is provided in each box

■ New reference





macroman™

The Efficient Solution for Pipetting up to 100 mL at once!



PERFORMANCE

- For all plastic & glass pipettes from 1 to 100 mL.
- Continuously adjustable speed: 25 mL in 4 sec.
- Environmentally friendly NiMH battery for 8 hours operation.
- Precise & smooth dosing button control: drop-by-drop, gravity mode and motorized speed.



Stable, safe & easy to pick up

OPTIMAL COMFORT

- Integrated, adjustable stand for easy handling when pipette attached.
- Large & soft-touch material dosing button.
- Light-weight.
- Quiet operation & vibration free.
- Ergonomic-shape handle with grip.



Soft & fatigue free pipetting

Description	Ordering reference
MACROMAN, EU plug	F110751
MACROMAN, JP plug	F110754
MACROMAN, US plug	F110752
MACROMAN, UK plug	F110753
MACROMAN, AUS plug	F110755



Complete your equipment with:

Horizontal or vertical & magnetic charging stand (with complete mounting kit) for busy laminar flow cabinet.

Unique adaptor for D5000 and D10mL PIPETMAN DIAMOND® Tips.

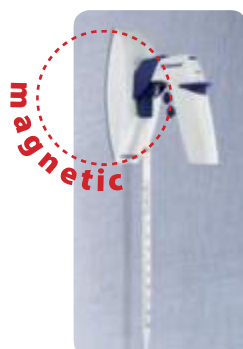

Description	Ordering reference
Charging stand	F1077501
0.45 µm standard filter	F1077504
0.45 µm sterile filter	F1077525
0.20 µm standard filter	F1077503
0.20 µm sterile filter	F1077526
Nose-piece	F1077506
Filter rubber	F1077502
Pipette mount	F1077505
Adapter for D5000 and D10mL PIPETMAN DIAMOND® Tips	F161287
1-year warranty	-



safe aspiration STATION

Safe and Simple Solution for Biological Liquid Waste Disposal!

COMFORT & FLEXIBILITY

- Quiet operation: Motor starts only when vacuum pressure drops.
- Compact design and small footprint: Allows for efficient use of space in laminar flow cabinets.
- Adjustable aspiration speed allows for quick and accurate aspiration.
- Handle accommodates different types of pipettes to aspirate from a variety of vessels.
- Always ready to use just press the handle-button to aspirate.
- Convenient coupling for quick bottle emptying.



SAFE & CONTAMINATION FREE

- Closed, stand-alone unit designed to prevent contamination hazards.
- All parts in contact with the liquid are autoclavable.
- In-line hydrophobic filter traps aerosols.
- Level detection to prevent overflow.
- Unbreakable bottle.
- Connect two handles to the Gilson Safe Aspiration Station with the Y-shape connector.

Description	Ordering reference
Gilson Safe Aspiration Station	F110741
Gilson Safe Aspiration Kit	F110742
Y-shape Connector	F1077418



safe aspiration KIT

GILSON SAFE ASPIRATION KIT

- 1 handle + tubing set + 1 holder.
- 1 stainless steel needle adaptor.
- 1 tip* adaptor.
- 1 tip adaptor with tip* ejector.
- 8-needle stainless steel adaptor.
- 8-tip adaptor with tip* ejector



* Compatible with PIPETMAN DIAMOND Tips: DL10, DFL10, DF30, DF100, D200, DF200, D300, DF300



Cell culture



Cell culture



ELISA test



Liquid aspiration
(supernatant, etc.)



minipuls **EVOLUTION**[®]

The Laboratory Peristaltic Pump You Can Trust!



The MINIPULS Evolution is the newest innovation from the makers of the MINIPULS 3, offering unmatched flexibility and performance for liquid transfer applications.



Unbeatable flow rate range from 0.2 μ L/min to 340 mL/min



Stackable pump heads for up to 16 channels



Medium and high flow pump heads can be used simultaneously in the same module

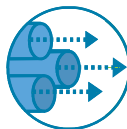

Reproducibility of flow rate on all channels with a variation \leq 0.1%



0.01 rpm readability below 10 rpm, perfect for accurate flowrate adjustment



Optimized 6-roller design limits pulsations



Offers back pressure resistance up to 0.3MPa (42psi)

GILSON ROBUSTNESS AND RELIABILITY

- Safe and durable design, can work 24/7.
- Stainless steel rollers for great durability and chemical resistance.
- The stepper motor and the spring loaded cartridges assure a high precision of flow rate despite tubing stretching: less than 2% variation after 24h in operation.



QUICK, FLEXIBLE & SAFE SET UP

- Cartridges snap in & out of the pump head for fast tubing change - no need to remove the pump head from the speed control module.
- Pump heads can be changed within seconds even while pump is operating - no tool required.
- Adjustable tubing occlusion for simple and fine pressure adjustment.
- Intuitive software interface with large LCD screen.

PATENTED

PATENTED

PATENTED

CLEAR SETTING DISPLAY ON THE LARGE LCD SCREEN

- Start/Stop.
- Variable flow rate and direction.
- Prime mode: purge tubing at the touch of the button.



How to select the most appropriate configuration?

1



SPEED CONTROL MODULE

Model	Ordering reference
MINIPULS Evolution speed control module	F110701

2



SELECT THE PUMP HEAD(S):

MF1 pump head with 1 cartridge,
0.2 μ L/min to 70 mL/min.
Ref. F110705



MF4 pump head with 4 cartridges,
0.2 μ L/min to 70 mL/min.
Ref. F110706

Stack up to 4 MF pump heads
together for up to 16 channels.



HF2 pump head with 2 cartridges,
1 mL/min to 340 mL/min.
Ref. F110707*

Stack up to 3 HF pump heads
together for up to 6 channels.

* Consult your local distributor for details / availability.

3

SELECT THE APPROPRIATE TUBING:

- Check the appropriate material according to your fluid's chemical compatibility.
- 4 types of tubing are available to choose from:
 - PVC for standard use.
 - Silicone for best biocompatibility.
 - Pharmed® for increased lifetime - conforms to USP & FDA class 4.
 - Isoversinic® for high chemical compatibility.
- Check the maximum required flow-rate.
- Choose tubing internal diameter, connectors and extensions from the table on page 41.

4

SELECT THE FOOTSWITCH PUMP CONTROL FOR INCREASED COMFORT

Ref. F1077081

Pharmed® and Isoversinic® are registered trademarks of Norton Performance Plastic Corp.



minipuls® 3

Pulse-Free Flow Peristaltic Pump!

HIGH PERFORMANCE AND VERSATILE

- Pulse-free flow (10 stainless steel rollers!).
- Excellent flow-rate accuracy and reproducibility.
- Wide flow-rate range from 0.3 µL/min to 220 mL/min.
- Operates at high pressures (up to 0.5 MPa).
- Low noise operation.



RELIABLE AND ROBUST

- High chemical resistance material (drive module and pump heads).
- Motor speed stability (high torque stepper motor).
- Built-in overflow system, in case of tubing leakage.



Adjustable cams allow fine flow-rate adjustment to minimize tubing wear and maximize their lifetime.



Two-stop calibrated tubing makes it easy to install tubing on the pump head.

Item	Max Flow Rate	Number of channels	Ordering reference
Pump Module MINIPULS 3			F155001
R1 Pump Head	up to 30 mL/min	1	F117604
R2 Pump Head	up to 30 mL/min	2	F117800
R4 Pump Head	up to 30 mL/min	4	F117606
R8 Pump Head	up to 30 mL/min	8	F117608
R2/HF Pump Head (High Flow)	up to 220 mL/min	2	F117830
R4/HF Pump Head (High Flow)	up to 220 mL/min	4	F117831

 A large choice of suitable tubing is available (see page 41)





MINIPULS Tubing

How to select the right tubing for your MINIPULS 3 or MINIPULS Evolution

A collection of tables and charts is available at www.gilson.com to be used as a guide for selecting the appropriate tubing.

- Most suitable material according to your sample's chemical compatibility.
- Large variety of internal diameters to reach desired flow rates.
- Appropriate connectors and extension tubing.

TUBING FOR R1, R2, R4, R8, MF1 & MF4 PUMP HEADS (LENGTH = APPROX 40 CM/ 16IN)

Material	Internal diameter (mm)	Reference tubing (calibrated tubing)	Color coded stops		Extension tubing (3m/118in)	Connectors	MINIPULS 3 Maximum Flow rate (mL/min)	MINIPULS Evolution Maximum Flow rate (mL/min)
PVC	0.25	F117932	●	●	F117952	F117985	0,407	0,574
	0.38	F117933	●	●	F117953	F117986	0,695	1,22
	0.51	F117934	●	●	F117954	F117986	1,415	1,90
	0.76	F117936	●	●	F117956	F117987	2,1	3,00
	1.02	F117938	○	○	F117958	F1179941	4,1	6,0
	1.30	F117940	○	○	F117960	F1179941	6,2	9,0
	1.52	F117942	●	●	F117962	F1179941	9	14
	1.65	F117943	●	●	F117963	F1179941	10	16
	2.06	F117945	●	●	F117965	F1179941	16	25
	2.29	F117946	●	●	F117966	F1179941	20	29
	2.79	F117948	●	○	F117968	F1179951	23	39
	3.16	F117949	●	○	F117969	F1179951	29	47
ISOVERSINIC®	0.5	F1817741	●	●	F117740	F117986	1,8	2,9
	1.0	F1817743	●	●	F117742	F1179941	4	10
	2.0	F1817745	●	●	F117744	F1179941	13	24
	3.0	F117747	●	●	F117746	F1179951	27	55
	4	F117749	●	●	F117748	-	33	70
SILICONE	0.6	F1825111	●	○	F1825131	F117987	1,5	3,2
	1.0	F1825112	○	○	F1825132	F1179941	4	7
	2.0	F1825113	●	●	F1825133	F1179951	15	21
	2.8	F1825114	●	○	F117975	F1179951	23	31
PHARMED®	0.5	F1825101	●	●	F1825121	F117986	1,4	2,5
	1.0	F1825102	○	○	F1825122	F1179941	5	7
	2.0	F1825103	●	●	F1825123	F1179951	15	24

TUBING FOR R2HF, R4HF & HF2 HIGH FLOW PUMP HEADS (LENGTH = 3M / 118IN)

Material	Internal diameter (mm)	Reference tubing (calibrated tubing)	MINIPULS 3 Maximum Flow rate (mL/min)	MINIPULS Evolution Maximum Flow rate (mL/min)
PVC	2.06	F117965	24	33
	2.29	F117966	29	41
	2.79	F117968	41	66
	3.16	F117969	49	85
	4.0	F117970	75	128
	5.0	F117980	113	179
	6.0	F117981	163	218
	8.0	F117982	213	340
ISOVERSINIC®	2.0	F117744	23	30
	3.0	F117746	48	67
	4.0	F117748	86	120
SILICONE	6.0	F117750	181	246
	2.0	F1825133	25	31
	3.0	F117975	44	57
	4.0	F117976	71	105
PHARMED®	5.0	F117977	115	148
	6.0	F117978	150	207
	7.0	F117979	220	300
	2.0	F1825123	26	31
PHARMED®	3.2	F1825124	57	77
	6.4	F1825125	171	240

Pharmed® and Isoversinic® are registered trademarks of Norton Performance Plastic Corp.



MINIPULS Applications

Electrophysiology of a rat brain cells

minipuls® 3

To measure electrical signals and intracellular calcium concentrations of neuronal cells at the same time, Mr. Kwang-Hyun Cho, PhD, a postdoctoral researcher from the College of Medicine at the Catholic University of Korea, uses a microscope focusing on a perfusion chamber drained by a MINIPULS 3.

The neuronal cells come from a rat brain slice bathed in a buffer inside the chamber. This buffer is an oxygenated saline solution that ensures the viability of the neuronal cells, which are very sensitive to oxygen.

// The MINIPULS 3 is very convenient for the re-circulation of solutions //

says Doctor Kwang-Hyun Cho when referring to a key benefit of the pump. Engineered with a 10-roller rotor, **the MINIPULS 3 produces smooth pulse-free flows**, which eliminate siphoning or clogging phenomenon, a significant advantage when circulating sensitive neuronal cells.

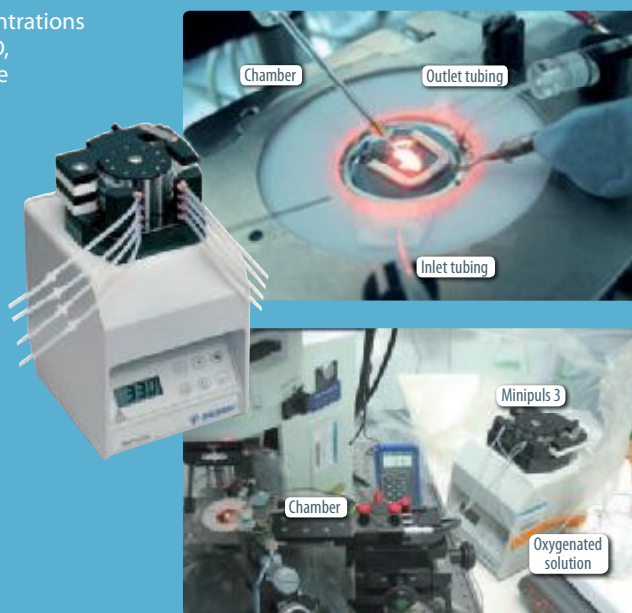

Study of bacterial biofilm

minipuls® EVOLUTION

In the Institute of Biology at the Leiden University, the molecular biology team seeks to identify *Pseudomonas* (*Pseudomonas putida*) genes and traits involved in efficient competitive root colonisation in order to understand how bacteria survive, proliferate, and compete in the rhizosphere after bacterisation of seeds. The MINIPULS Evolution is used to study bacterial biofilms in flowcell chambers. Bacteria grow in flowcell chambers fed by an oxygenated solution and media. **The MINIPULS Evolution is used to bring this solution to the chambers and recycle it.**

The growth media was delivered at 0.125 mL/min to the flowcell system. Elen Lagendijk, technical assistant at the molecular and biology department, says that

// One of the outright benefits of the Gilson MINIPULS Evolution peristaltic pump is that it enables the operator to replace tubing, add or remove channels while the pump is running without interrupting the flow in the other chambers... //

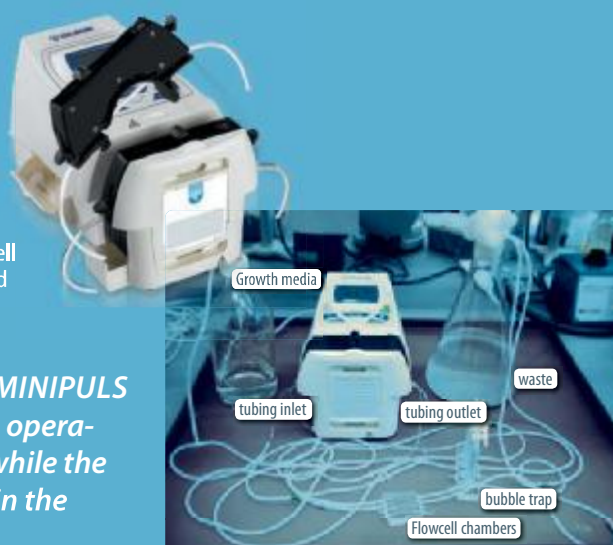



GmCLab

Quick and Safe Mini-centrifuge by Gilson!

GmCLab is a fixed-speed personal mini-centrifuge that quickly separates particles from the supernatant in a solid-liquid mixture or spin down liquids to the bottom of a microtube.

COMPACT DESIGN

- Small footprint allows for easy integration on a busy workbench.
- Accommodates 8 micro-tubes of 1.5 or 2.0 mL, 2 strips of 8-PCR (0.2 mL) tubes or 16 single PCR tubes.

SIMPLE TO USE

- Simple spin activation by closing the lid.
- Pinch-type connector to quickly exchange rotors – no tool needed.
- Lid opens up to an angle of 160° to allow easy access to the tubes.
- Dynamic brake for emergency stop.

ROBUST

- Reinforced lid hinge cylinders.
- Maintenance-free.
- One-year warranty.



Description	Ordering reference
GmCLab, EU plug (230 V / 50-60 Hz)	F110731
GmCLab, US plug (120 V / 50-60 Hz)	F110732
GmCLab, UK plug (230 V / 50-60 Hz)	F110733
GmCLab, AU plug (230 V / 50-60 Hz)	F110734
GmCLab, JP plug (100 V / 50-60 Hz)	F110735
Grey boss for GmCLab	F1077306
Housing and lid assembly	F1077301
Fuses 0.5A, pack of 2	F1077305
Rotor for 1.5/2.0 ml tubes	F1077303
Rotor for 8-PCR tube strips	F1077304





ISO 17025 & Gilson Pipettes

Gilson Pipette with a Calibration Certificate Issued by ISO 17025-Accredited Laboratory

Around the world, the accreditation of pipette testing and calibration laboratories is based on the ISO 17025 international standard. ISO 17025 accreditation enables test data to be internationally validated and accepted.

This system of international mutual recognition allows test data to be equivalent throughout the world because they are linked to the same metrological chain of international standard weight.

Hence, the measure of the uncertainties derived from equipment, technicians, pipettes and tips which indicates the error range attributable to the measured quantities allows the accredited laboratory to attest to the pipette's reliability and ensures that it is within acceptable limits after calibration.

- Gilson ISO 17025-accredited laboratory in France provides the undisputable guarantee and confidence that our Quality System and Standard Operating Procedures have been thoroughly evaluated and approved by a legitimate third party.
- Gilson offers accredited calibration for new and serviced pipettes in full compliance with the ISO 17025 & ISO 8655 requirements.
- A certificate of calibration, approved by the French organization of accreditation (COFRAC), is delivered with each pipette. The certificate is recognized by international organizations of accreditation.
- In an on-going effort to address the growing demands for enhanced traceability and affordable ISO 17025 solutions, Gilson has been granted accreditation by the COFRAC for a special Gilson 3 volumes x 4 measurements method in addition to being accredited for the standardized ISO 8655 3 volumes x 10 measurements method. This enables us to offer ISO 17025 calibration at an attractive price.
 - The standardized ISO 8655 method (3 volumes x 10 measurements).
 - The special Gilson method (3 volumes x 4 measurements).



NEW PIPETTES with a Calibration Certificate Issued by the Gilson ISO 17025 Accredited Laboratory

To order a new pipette with a calibration certificate, add a **C** at the end of the reference for a 3 x 10 measurements method (standard ISO 8655), or a **CG** for a 3 x 4 measurements (Gilson method, available in French service center recognized by accreditation organization).

Example:

- You need a **P100 delivered with a 3 x 10 measurements**
→ Order the following reference: **F123615C**
- You need a **P2N delivered with a 3 x 4 measurements**
→ Order the following reference: **F144561CG**

All mechanical, repetitive and motorized pipettes can be delivered with calibration certificate.

Please contact your nearest distributor for calibration certificate request form.



SERVICED PIPETTES with a Calibration Certificate Issued by ISO 17025 Accredited Laboratory

Some Gilson service centers in the world are accredited (ISO 17025) for pipette calibration when using the gravimetric method (ISO 8655).

If your nearest service center is accredited, you can ask for a certificate of calibration including information about the conformity of your pipette. This certificate is recognized throughout the world and linked to the International System of Units.

If your local Gilson service center is not yet accredited, Gilson's Accredited Laboratory of Calibration, based in France, can provide you the following service offers:

1 ISO 8655 3 x 10 MEASUREMENTS METHOD (no tip change)

Ordering reference	Description
PCI 001	Fixed volume Pipettes
PCI 002	Adjustable volume Pipettes
PCI 003	8 channel Pipettes
PCI 004	12 channel Pipettes

2 GILSON 3 x 4 MEASUREMENTS METHOD (no tip change)

Ordering reference	Description
PGCI 001	Fixed volume Pipettes
PGCI 002	Adjustable volume Pipettes
PGCI 003	8 channel Pipettes
PGCI 004	12 channel Pipettes



Services

Gilson Service Center Makes You The Priority!

Pipettes are precision instruments used daily in routine laboratory work and are often involved in critical laboratory applications. Like any other instrument, they need to be serviced and calibrated regularly to ensure that they perform to the highest standards.

In line with the ISO 8655, Gilson recommends disassembling, cleaning, replacement of worn parts and checking of the calibration every 6 months or at least once a year. Gilson has a worldwide network of specialists present in more than 50 countries offering a breadth of services to address the demanding requirements of international standards, Good Laboratory Practices and internal procedures.

Ultimately, we work to provide you with flexible solutions to extend the lifetime of your pipette and assure you the highest level of continued accuracy and precision at a minimal cost.

Gilson Service Center makes you the priority

- No surprises, you pay for what is on the estimate
- We propose various service offers adapted to your budget
- We guarantee that Gilson genuine spare parts are used in all repairs
- We guarantee that the personnel is regularly audited and the equipment checked daily

GILSON TRAINING*

Gilson's distributors conduct comprehensive seminars to train you and your personnel. **Training programs cover all aspects of service and operation of your pipettes.**

Gilson's local representatives have completed extensive training in all aspects of service and operation of Gilson products and services. Your local distributor can offer you extensive pipette training covering topics such as:

- Good handling practices, gesture and posture.
- Use and applications.
- GLP requirements, quality control, applicable standards, traceability, and record keeping.
- Preventive maintenance and calibration.

Contact your nearest Gilson Service Center for availability of these offers.

**Service offer listed above and offered by Gilson may differ country by country. Please contact your local distributor for details.*

GILSON SERVICE NETWORK OF TRAINED DISTRIBUTORS

All Gilson technicians are highly qualified through extensive training by Gilson at the factory and share Gilson's experience. Their skills are continuously improved for new and upgraded products. Gilson Service Centers are routinely audited to verify their abilities.

GILSON PREVENTIVE MAINTENANCE, REPAIR & CALIBRATION SERVICES

- Pipettes are a staple of most laboratories and probably one of the most extensively used pieces of equipment. The pipette is made of a variety of mechanical and/or electronic parts moving against each other that are often exposed to corrosive or hazardous chemicals. This exposure may result in barely visible damage that may not be discovered unless regular service is carried out.

For example:

- The pipette has been tested on the balance, and is imprecise and/or inaccurate.
 - The pipette leaks after a long period of use.
 - The pipette leaks after having been exposed to contaminating liquids.
 - The piston seal and/or O-ring are worn out.
 - The stainless steel piston is scratched.
 - The tip-holder or other parts (tip-ejector, push button, connecting nut, etc) are damaged, chemically attacked or worn.
- Servicing your pipette regularly will provide you peace of mind regarding its performance and reliability. Gilson offers flexible service solutions that suit your needs:
 - **Diagnosis, repairs, and calibration.**
 - **Preventive maintenance contract to offer the level of service most appropriate to your needs** (what, how often, number of pipettes, cycle time, etc).
 - **Calibration by gravimetric method** to check the performance of your pipettes according to the ISO 8655 standard, including ISO17025 calibration with the Calibration certificate delivery, adapted to your budget (see pages 44-45).

ON-SITE SERVICE

Gilson's qualified technicians are available to visit your facility for any of the following:

- **Diagnosis:** Check that your Gilson pipettes function correctly and are mechanically sound.
- **Repairs:** Replacement of genuine spare parts.
- **Upgrade of PIPETMAN:** Systematic replacement of key components with upgraded parts.
- **Pipette Clinics:** Servicing of all Gilson pipettes. Servicing may include cleaning, decontamination, repair, (adjustment if needed) and calibration.

THE "CENTER OF EXCELLENCE" LABEL

With a clear focus on developing the quality of service to the Gilson pipette users, the company launched the "Center of Excellence" audit campaign in 2005. **The "Center of Excellence" label rewards the centers that fully fulfill all Gilson's requirements.** While no detail is overlooked, the main objective of the audits is to drive the entire Gilson network towards excellence of their service. Audits provide guidance to support the implementation of the necessary means to achieve excellence.

The Center of Excellence Certificate and the use of the numbered label ensure the highest quality of Gilson service and guarantee that the Service Center performs repairs and calibration according to Gilson's requirements.

Companies that have successfully completed Gilson's recommended program may use the Center of Excellence label as a graphic symbol to let clients know they have demonstrated the expertise required to diagnose, repair and calibrate.



CENTER OF EXCELLENCE

DO-IT-YOURSELF PERFORMANCE CHECK: WEIGHING KIT

The weighing kit is intended for end-users' use to check the performance of their Gilson pipettes across the full range of volumes from 1 µL to 10 mL. It consists of:

- 4 different weighing containers, for receiving the dispensed liquid on the balance pan during calibration.
- 3 reservoirs used to hold the distilled water during the calibration procedure.
- Filters.
- Tweezers.
- And a User's Guide, suitable for the gravimetric method according to ISO 8655 standard.

Gilson Requirements

1. Undergo regular Gilson audits on technical aspects, personnel skills, service quality and service offers.
2. Follow regular training.
3. Repair and calibrate in accordance with Gilson's servicing procedures or procedures validated by Gilson.
4. Repair the entire Gilson pipette range.
5. Repair Gilson pipettes with genuine spare parts.
6. Monitor environmental conditions.
7. Use correct balances (including 6-digit balance to calibrate volumes < 20 µL).
8. Maintain a comprehensive Service offer that includes:
 - a. Diagnosis, repairs, and calibration by gravimetric method (ISO 8655 Standard).
 - b. Maintenance.
 - c. On-site pipette service.
9. Comply with local standards and regulations.
10. Refuse sales of Gilson spare parts to unauthorized companies.

Description	Ordering reference
Weighing Kit	F144700
10 Filters for Weighing Kit	F123854





Replacement Parts

Use Gilson Genuine Spare Parts!

Spare parts manufactured by Gilson are products of intensive research and stringent quality control, guaranteed to deliver value and assure reliability and precision.

Having your pipettes regularly serviced by a Gilson certified and audited service center, staffed by qualified technicians and using genuine Gilson spare parts is the best way to guarantee high performance and trouble-free pipetting.

Since 2003, all PIPETMAN tip-holders, pistons and tip ejector heads are embossed with the Gilson trident to protect users from counterfeit products.

Gilson spare parts are only available from your local, authorized Gilson representative.



 For PIPETMAN Ultra and PIPETMAN Concept Spare Parts, please contact your local distributor.

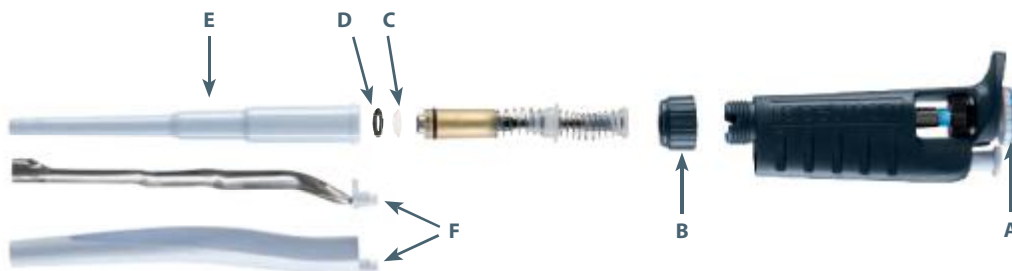

PIPETMAN G
(P1000G)

PIPETMAN G Service Kits	Ordering reference								
Item	Key	P2G	P10G	P20G	P100G	P200G	P1000G	P5000G	P10 mLG
Service kit 1 st level (1 tip holder, 3 piston seals guide and 3 O-rings)	C+D+E	F144501	FA07001	FA07002	FA07003	FA07004	FA07005	FA07021	FA07022
Service kit 2 nd level (1 push-button, 1 connecting nut, 1 stainless steel ejector, 1 plastic ejector, 2 ejector adapters respectively for metal and plastic PIPETMAN P2G/ P10G)	A+B+F	F1619702	F1619712	F1619722	F1619732	F1619742	F1619782	*	*

* Not applicable with this model. Refer to the User's Guide (LT801122) for details.

PIPETMAN G Replacement Parts	Ordering reference								
Item	Key	P2G	P10G	P20G	P100G	P200G	P1000G	P5000G	P10 mLG
Seal & O-ring (5 sets)	C+D	F144861	*	*	*	*	*	FA07017	FA07018
Seal guide & O-ring (5 sets)	C+D	*	FA07012	FA07013	FA07014	FA07015	FA07016	*	*
Adapter for Dual-position Tip ejector (plastic part only, 5 sets)	**	F144879	F144879						
Tip-ejector extension	**	F2070903	F2070903						

* Not applicable with this model. **Not shown. Refer to the User's Guide (LT801122) for details.



PIPETMAN L
(P200L)

PIPETMAN L Service Kits	Ordering reference								
Item	Key	P2L	P10L	P20L	P100L	P200L	P1000L	P5000L	P10 mL L
Service kit 1 st level (1 tip holder, 3 piston seals guide and 3 O-rings)	C+D+E	F144501	FA07001	FA07002	FA07003	FA07004	FA07005	FA07021	FA07022
Service kit 2 nd level (1 push-button, 1 connecting nut, 1 stainless steel ejector, 1 plastic ejector, 2 ejector adapters, respectively for metal and plastic PIPETMAN P2L/P10L)	A+B+F	FA07006	FA07007	FA07008	FA07009	FA07010	FA07011	*	*

* Not applicable with this model. Refer to the User's Guide (LT801124) for details.

PIPETMAN L Replacement Parts	Ordering reference								
Item	Key	P2L	P10L	P20L	P100L	P200L	P1000L	P5000L	P10 mL L
Seal & O-ring (5 sets)	C+D	F144861	*	*	*	*	*	FA07017	FA07018
Seal guide & O-ring (5 sets)	C+D	*	FA07012	FA07013	FA07014	FA07015	FA07016	*	*
Adapter for Dual-position Tip ejector (plastic part only, 5 sets)	**	F144879	F144879						
Tip-ejector extension	**	F2070903	F2070903						

* Not applicable with this model. **Not shown. Refer to the User's Guide (LT801124) for details.

PIPETMAN L Multi

PIPETMAN L Multi Replacement Parts	Ordering reference				
Item	Key	8x10/8x20	12x10/12x20	8x200/8x300	12x200/12x300
Tip-ejector	A	F507005	F507006	F507005	F507006
Ejector lock	B	F507008	F507008	F507008	F507008
Ejector spacer	C	F507001	F507003	F507001	F507003
Ejector spacer D10	D	F807114	F807115	*	*

* Not applicable with this model. Refer to the User's Guide (LT801124) for details.

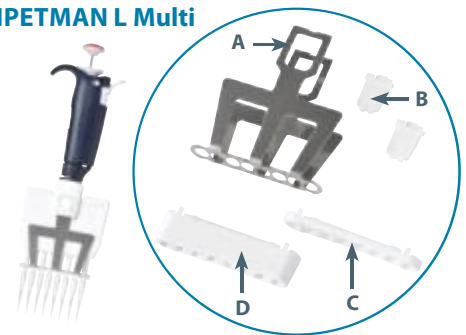

PIPETMAN L Fixed
(F200L)

PIPETMAN L Fixed Service Kits	Ordering reference								
Item	Key	F1L/F2L	F5L/F10L	F20L/F25L	F50L/F100L	F200L	F250L	F300L/F400L/ F500L/F1000L	F5000L
Service kit 1st level (1 tip holder, 3 piston seals guide and 3 O-rings)	C+D+E	F144501	FA07001	FA07002	FA07003	FA07004	FA07004	FA07005	FA07021
Service kit 2nd level (1 push button, 1 connecting nut, 1 plastic tip ejector, 1 tip ejector extension for F1L, F2L, F5L, F10L)	A+B+F	FA07067	FA07068	FA07069	FA07070	FA07071	FA07073	FA07072	*

* Not applicable with this model. Refer to the User's Guide (LT801124) for details.

PIPETMAN L Fixed Replacement Parts	Ordering reference								
Item	Key	F1L/F2L	F5L/F10L	F20L/F25L	F50L/F100L	F200L/F250L	F300L/F400L/ F500L/F1000L	F5000L	
Seals & O-ring (5 sets)	C+D	F144861	*	*	*	*	*	FA07017	
Seals guide & O-ring (5 sets)	C+D	*	FA07012	FA07013	FA07014	FA07015	FA07016	*	
Tip-ejector extension	**	F2070903	F2070903	*	*	*	*	*	
Lubricant vial	**	5440011070	5440011070	5440011070	5440011070	5440011070	5440011070	5440011070	

* Not applicable with this model. **Not shown. Refer to the User's Guide (LT801124) for details.



Replacement Parts

Use Gilson Genuine Spare Parts!

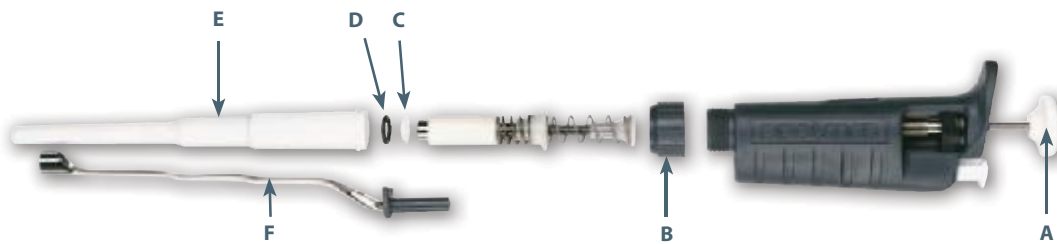

PIPETMAN Classic
(P1000)

PIPETMAN Classic Service Kits	Ordering reference									
	Item	Key	P2	P10	P20	P100	P200	P1000	P5000	P10 mL
Service kit 1 st level (1 tip holder, 3 piston seals and 3 O-rings)	C+D+E	F144501	F144502	F144495	F144496	F144497	F144498	F144499	F144503	
Service kit 2 nd level (1 push-button, 1 connecting nut, 1 tip ejector and 1 tip ejector adapter only for PIPETMAN P2/P10)	A+B+F	F161970	F161971	F161972	F161973	F161974	F161978	*	*	

* Not applicable with this model. Refer to the User's Guide (LT801120) for details.

PIPETMAN Classic Replacement Parts	Ordering reference									
	Item	Key	P2	P10	P20	P100	P200	P1000	P5000	P10 mL
Push-button assembly	A	*	*	*	*	*	*	*	F144787	F161281
Seal & O-ring (5 sets)	C+D	F144861	F144862	F144863	F144864	F144865	F144866	F144867	F144867	F161829
Tip-holder	E	*	*	*	*	*	*	*	F123608	F161263
Adapter for Dual-position Tip ejector (plastic part only, 5 sets)	**	F144879	F144879	*	*	*	*	*	*	*
Bags of 10 filters		*	*	*	*	*	*	*	F161280	F161280
Bags of 100 filters	**	*	*	*	*	*	*	*	F161241	F161241

* Not applicable with this model. **Not shown. Refer to the User's Guide (LT801120) for details.



PIPETMAN Neo
(P1000N)

PIPETMAN Neo Service Kits	Ordering reference							
	Item	Key	P2N	P10N	P20N	P100N	P200N	P1000N
Service kit 1 st level (1 tip holder, 3 piston seals and 3 O-rings)	C+D+E	F144501	F144502	F144495	F144496	F144497	F144498	
Service kit 2 nd level (1 push-button, 1 connecting nut, 1 tip ejector and 1 tip ejector adapter only for PIPETMAN P2N/P10N)	A+B+F	F1619701	F1619711	F1619721	F1619731	F1619741	F1619781	

* Not applicable with this model. **Not shown. Refer to the User's Guide (LT801521) for details.

PIPETMAN Neo Replacement Parts	Ordering reference							
	Item	Key	P2N	P10N	P20N	P100N	P200N	P1000N
Seal & O-ring (5 sets)	C+D	F144861	F144862	F144863	F144864	F144865	F144866	
Tip-holder	E	*	*	*	*	*	*	
Adapter for Dual-position Tip ejector (plastic part only, 5 sets)	**	F144879	F144879	*	*	*	*	

* Not applicable with this model. **Not shown. Refer to the User's Guide (LT801521) for details.

PIPETMAN Neo multi Replacement Parts	Ordering reference					
	Item	Key	8x20	12x20	8x200	12x200
Tip-ejector	A	F507005	F507006	F507005	F507006	
Ejector lock	B	F507008	F507008	F507008	F507008	
Ejector spacer	C	F507001	F507003	F507001	F507003	

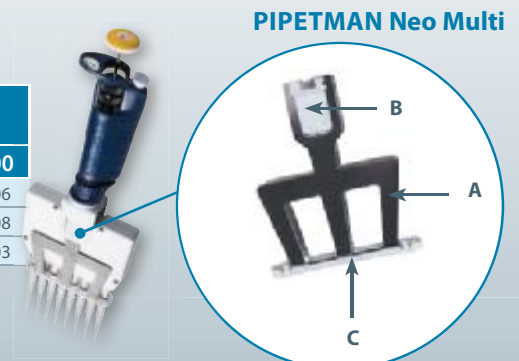

PIPETMAN Neo Multi

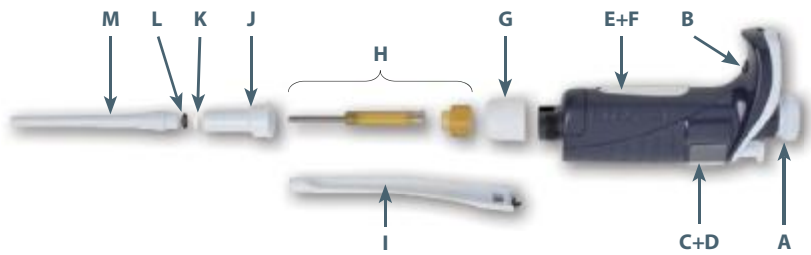

PIPETMAN M

PIPETMAN M Replacement Parts	Ordering reference				
	Key	P10M	P20M	P200M	P1000M
Button assembly	A	F807001	F807002	F807003	F807004
Power tub cover	B	F807022	F807022	F807022	F807022
Battery tag, 1x4	C	F807013	F807013	F807013	F807013
Battery window	D	F807005	F807005	F807005	F807005
Ejector tag, 1x4	E	F807014	F807014	F807014	F807014
Ejector window	F	F807006	F807006	F807006	F807006
Connecting nut	G	F807012	F807012	F807012	F807012
Piston assembly	H	F807017	F807018	F807019	F807020
Tip ejector assembly	I	F807008	F807009	F807010	F807011
Tip-holder, upper part	J	F2070117	F2070117	F2070517	F20705617
Seal, U10/C10/M10, 5 sets	K	F161902	*	*	*
Seal & O-ring, P20/F2-20, 5 sets	L+K	*	F144863	*	*
O-ring, for PIPETMAN U200/M200 (x5)	L	*	*	F2070501	*
O-ring, U1000/M1000/C1200, set of 5	L	*	*	*	F2070601
Tip-holder, lower part	M	F2070218	F2070318	F2070518	F2070618
Power Supply USB	**	F807015	F807015	F807015	F807015
Lubricant tube 3.5g, Concept	**	*	F3070902	F3070902	F3070902

*Not applicable with this model. **Not shown. Refer to the User's Guide (LT801527) for details.

PIPETMAN M Multi Replacement Parts	Ordering reference						
	Key	8x20	12x20	8x200	12x200	8x300	12x300
Button assembly	A	F807112	F807112	F807003	F807003	F807116	F807116
Power tub cover	B	F807022	F807022	F807022	F807022	F807022	F807022
Battery tag, 1x4	C	F807013	F807013	F807013	F807013	F807013	F807013
Battery window	D	F807005	F807005	F807005	F807005	F807005	F807005
Ejector tag, 1x4	E	F807014	F807014	F807014	F807014	F807014	F807014
Ejector window	F	F807006	F807006	F807006	F807006	F807006	F807006
Tip-ejector assembly	N	F507005	F507006	F507005	F507006	F507005	F507006
Ejector lock	O	F507008	F507008	F507008	F507008	F507008	F507008
Ejector spacer	P	F507001	F507003	F507001	F507003	F507001	F507003
Power Supply USB	**	F807015	F807015	F807015	F807015	F807015	F807015

*Not applicable with this model. **Not shown. Refer to the User's Guide (LT801527 and LT801534) for details.

PIPETMAN Fixed Replacement Parts	Ordering reference				
	F2 to F20	F25 to F100	F200	F250 to F1000	F5000
Piston assembly	F123845	F144611	F123846	F123847	F123848
Seal & O-ring (5 sets)	F144863	F144864	F144865	F144866	F144867
Connecting Nut	F144723	F144723	F144723	F144723	*
Tip ejector	F144766	F144767	F144768	F144769	*
Service kit 1st level (1 tip holder, 3 piston seals and 3 O-rings)	F144495	F144496	F144497	F144498	F144499
Adjustment key	F123674	F123674	F123674	F123674	F123674
Bags of 10 filters	*	*	*	*	F161280
Bags of 100 filters	*	*	*	*	F161241

*Not applicable with this model. Refer to the User's Guide (LT801118) for details

PIPETMAN M Multi

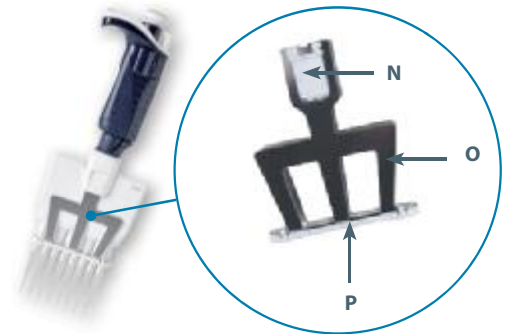

PIPETMAN Fixed



MICROMAN

MICROMAN Replacement Parts	
Item	Ordering reference
Button assembly, blue, M10	F148568
Button assembly, blue, M100	F148569
Button assembly, blue, M25	F148615
Button assembly, blue, M50	F148616
Button assembly, blue, M250	F148618
Button assembly, blue, M1000	F148619

Refer to the User's Guide (LT801502) for details

DISTRIMAN

DISTRIMAN Replacement Parts	
Item	Ordering reference
Push-button assembly	F164040
Piston retaining assembly	F164070
Red flag (set of 5)	F164042
Retaining spring	F1864052

Refer to the User's Guide (LT801285) for details





Automated Instrumentation

prep LC | SPE | sample preparation

In addition to its Manual Liquid Handling product line, Gilson also provides its customers with an extensive range of instrumentation products. We strive to create high quality, dependable solutions for today's demanding liquid chromatography, solid phase extraction, and gel permeation chromatography clean-up requirements.

Gilson has worldwide sales and service supporting the pharmaceutical, biotech, environmental, clinical, food and forensic markets.

Our primary focus is on purifying samples via preparative HPLC, automated SPE or through GPC clean-up. Gilson focuses on early drug discovery and development with our preparative HPLC systems.

Gilson automated SPE systems and GPC clean-up systems support environmental, food, clinical and forensic markets performing a wide variety of clean-up applications.

WHAT'S NEW IN AUTOMATED INSTRUMENTATION?

GX-241 Liquid Handler

Small in size... Big on performance and flexibility!



The GX-241 Liquid Handler: A compact workhorse that provides the perfect balance of size, performance, and capabilities to individual labs!

Ideally suited for applications and labs where bench space is at a premium, the GX-241 Liquid Handler features a large injection volume range of 1 μ L to 5 mL using a minimal dead volume direct injection design.

The GX-241 also features two transfer ports for delivering sample to off-bed detection devices in Flow Injection Analysis (FIA). This two rack capacity liquid handler has the ability to hold hundreds of samples ranging from 2 mL vials to 100 mm test tubes. The flexible platform can also hold up to 4 shallow or deep well 96 well microplates.

More info? Please consult our website!





Appendix

Chemical Compatibility Table

Product		Steel	PET	Nitril	EPDM	LCP	PA	PBT	PC	PE	PVDF	TPX	POM	PP
Acetamide		++	N/A	++	++	N/A	++	N/A	N/A	++	N/A	N/A	++	++
Ethyl acetate		++	+	-	++	++	++	++	++	++	++	+	N/A	++
Acetone		++	+	-	++	++	++	++	-	++	++	+	+	++
Acetonitrile		++	N/A	+	++	+	N/A	N/A	-	++	+	N/A	N/A	++
Acetic acid	20%	++	++	+	++	++	++	N/A	++	++	++	++	++	++
	50%	++	++	+	++	++	-	N/A	+	++	++	++	++	++
	100%	++	++	-	++	+	-	N/A	-	++	++	+	+	++
Hydrochloric acid	10%	-	++	++	++	++	-	++	++	++	++	++	++	++
	20%	-	+	+	++	++	-	+	++	++	++	++	+	++
	37%	-	-	-	++	++	-	-	+	++	++	++	-	++
Hydrofluoric acid	20%	+	+	-	++	+	-	+	++	++	++	++	+	++
	40%	-	+	-	++	-	-	-	+	++	++	++	+	++
Formic acid	100%	++	N/A	-	++	++	-	+	-	++	++	N/A	+	++
Nitric acid	10%	++	++	+	++	++	-	++	++	++	++	++	+	++
	30%	++	+	-	+	++	-	+	++	++	++	++	-	+
	65%	++	-	-	-	+	-	-	+	+	+	++	-	-
Phosphoric acid	20%	++	N/A	+	++	N/A	-	++	++	++	++	++	+	++
	85%	++	N/A	-	++	N/A	-	++	++	++	++	++	-	++
Propionic acid	50%	++	-	+	N/A	N/A	++	++	+	++	++	N/A	-	++
	100%	++	-	-	N/A	N/A	+	++	-	++	++	N/A	-	++
Sulfuric acid	20%	++	++	+	+	++	+	++	++	++	++	++	+	++
	50%	++	++	-	+	++	-	+	++	++	++	++	-	++
	95%	++	+	-	-	-	-	-	+	+	+	++	-	+
Trifluoroacetic acid	20%	++	N/A	-	N/A	N/A	+	N/A	++	++	++	N/A	++	++
	80%	++	N/A	-	N/A	N/A	-	N/A	+	++	++	N/A	+	++
	100%	++	N/A	-	N/A	N/A	-	N/A	-	++	++	N/A	-	++
Benzyl alcohol		++	++	-	N/A	N/A	+	N/A	-	++	++	++	-	++
Aniline		++	-	+	++	N/A	++	N/A	-	+	++	N/A	+	++
Butanol / Butyl alcohol		++	++	++	++	N/A	++	++	++	++	++	N/A	++	++
Chloroform		++	-	-	-	N/A	+	-	-	+	++	+	+	-
Cyclohexane		++	++	++	-	N/A	++	N/A	++	++	-	+	++	+
Diacetone alcohol		++	++	+	N/A	N/A	N/A	N/A	N/A	N/A	+	N/A	N/A	++
Methylene chloride		++	+	-	-	N/A	-	-	-	+	++	++	++	+
Diethylene glycol		++	N/A	++	++	++	N/A	N/A	N/A	++	++	++	++	++
Dimethylformamide (DMF)		++	++	-	+	++	++	++	-	++	-	++	++	++
Dimethylsulfoxide (DMSO)		++	N/A	-	N/A	N/A	+	N/A	-	++	N/A	N/A	N/A	N/A
Dioxane (1,4)		++	++	-	+	N/A	++	++	-	++	+	N/A	++	+
Ethanol		++	++	++	++	++	++	++	++	++	++	++	++	++
Ether		++	++	++	+	N/A	++	++	++	+	++	+	++	++
Formaldehyde		++	++	++	++	N/A	++	N/A	++	++	++	++	++	++
Hexane		++	N/A	++	-	+	++	++	++	+	++	+	++	++
Hydrogen peroxide	50%	++	N/A	+	++	N/A	++	++	++	++	++	++	++	++
Ammonium hydroxide	20%	++	++	++	++	N/A	N/A	+	-	++	N/A	++	++	++
Sodium hydroxide	10%	++	+	++	++	++	++	+	-	++	++	++	++	++
	40%	++	-	+	++	++	++	+	-	++	++	++	++	++
Sodium hypochlorite	15% Cl	+	N/A	+	++	++	++	++	++	++	++	++	-	+
Methanol		++	++	++	++	+	++	++	+	++	++	++	++	++
Methyl ethyl ketone		++	++	-	+	++	++	++	-	++	-	+	+	++
Pentane		++	N/A	++	-	N/A	N/A	N/A	++	++	++	+	++	N/A
Tetrahydrofuran (TH-)		++	++	+	+	+	++	+	-	-	+	+	N/A	+
Urea		++	++	N/A	N/A	-	++	++	N/A	++	++	N/A	++	++

PET = Polyethylene Terephthalate
Nitril = Nitril
EPDM = Ethylene Propylene
LCP = Liquid Cristal Polymer
PA = Polyamide
PBT = Polybutylene Terephthalate

PC = Polycarbonate
PE = Polyethylene
PVDF = Polyvinylidene fluoride
TPX = Polymethylpentene
POM = Polyoxymethylene
PP = Polypropylene

++ No chemical degradation
+ Medium resistance to chemical agents
- Low resistance to chemical agents
N/A No data available



Websites and Literature

Sources of information!

Log on to gilson.com now to learn more about Gilson and all our products!

Discover everything about:

[PIPETTES](#) | [TIPS](#) | [SERVICE](#)

[PREP LC](#) | [SPE](#) | [SAMPLE PREPARATION](#)



[FIND YOUR NEAREST DISTRIBUTOR](#)

[FIND OUT ABOUT GILSON'S COMMITMENT TO QUALITY](#)



and much more!

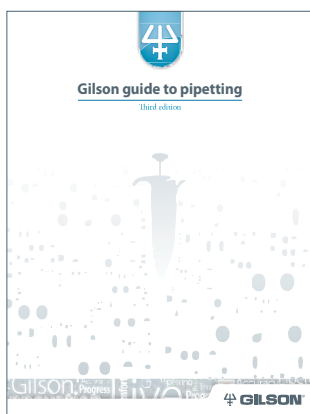

GILSON GUIDE TO PIPETTING

Ordering reference: LT800353

Learn the basics about pipetting techniques, preventing contamination, calibration and more!



2 MINUTE INSPECTION POSTER (PIPETMAN Classic & Neo)

Ordering reference: LT800434E

Preventive maintenance information for your PIPETMAN® pipette on a poster.



2 MINUTE INSPECTION POSTER (PIPETMAN G & L)

Ordering reference: LT800520

Preventive maintenance information for your PIPETMAN® G or PIPETMAN L pipette on a poster.

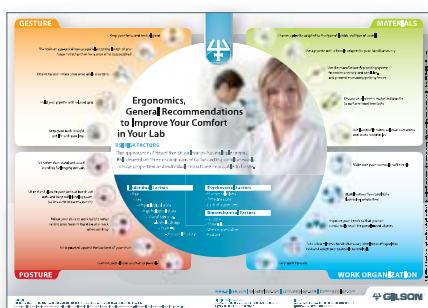

ERGONOMICS POSTER

Ordering reference: LT800476E

Gilson's recommendations to improve your comfort in your lab: gesture, posture, materials and work organisation.

Join our communities...



«Gilson pipetman»



www.gilsonpipetman.blogspot.com/



<http://twitter.com/Pipetman>



«Gilson pipetman pipettes»

...get exclusive **news**, enjoy our **training videos**, and **chat** with our team to learn everything you want about Gilson!

Distributed by



www.gilson.com | sales@gilson.com | service@gilson.com | training@gilson.com

 **GILSON®**



Gilson, Inc. World Headquarters | 3000 Parmenter Street | P.O. Box | 620027 Middleton | WI 53562-0027 | USA
Tel: (1) 800-445-7661 or (1) 608-836-1551 | Fax: (1) 608-831-4451

Gilson S.A.S. | 19, avenue des Entrepreneurs | BP 145, F-95400 Villiers-le-Bel, FRANCE
Tel: (33-1) 34 29 50 00 | Fax: (33-1) 34 29 50 20



LT800524/A © 03/2013 Gilson SAS.
All rights reserved. All trademarks are the property of Gilson Inc. and its subsidiaries.